

BONASSI



UNDERWATER REVOLUTION



WWW.BONASSI.IO

PHOTOGRAPHY: @JUANPOUJARCINEMA

2023

   /BONASSI.OFFICIAL

#UNDERWATERREVOLUTION

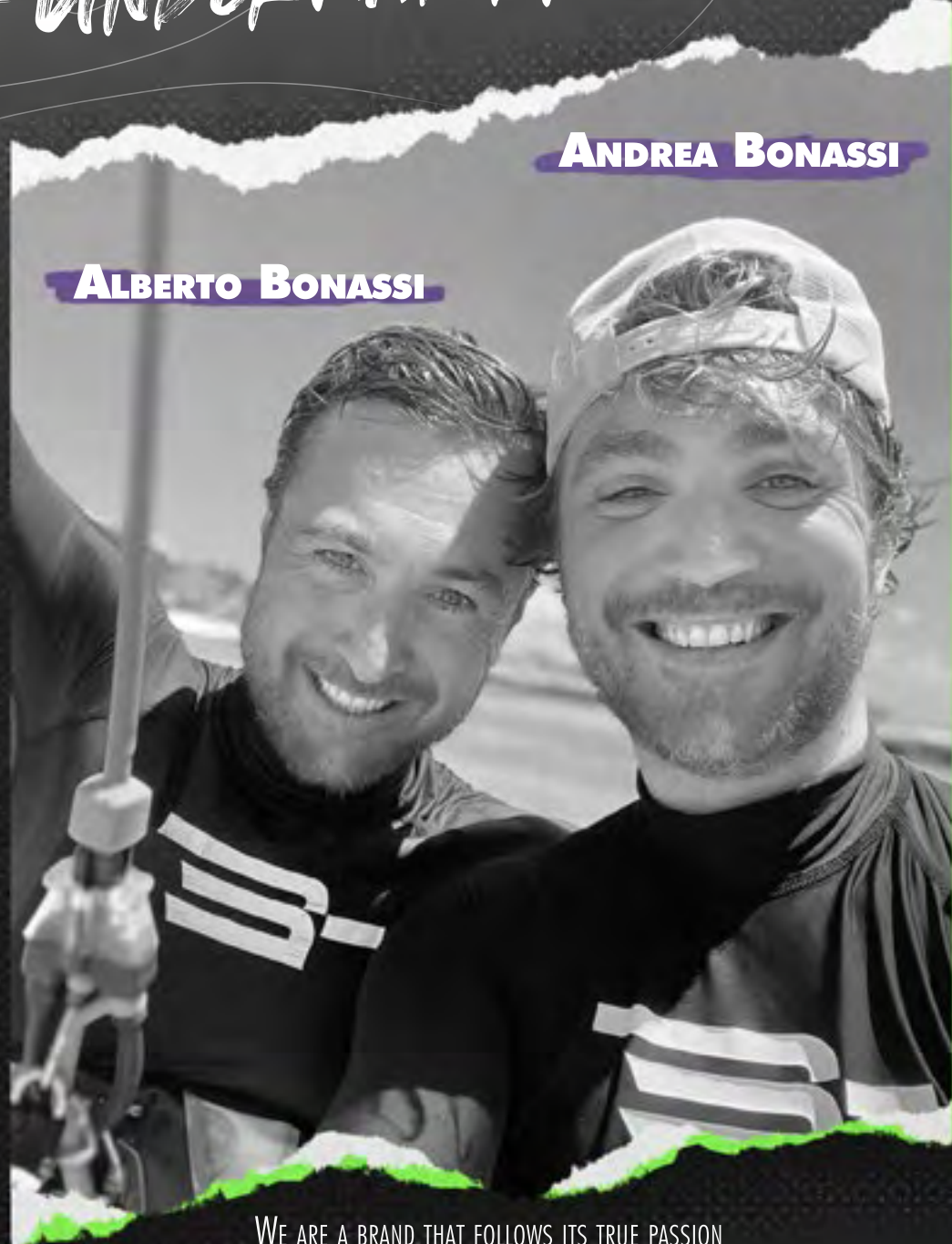

WE ARE A BRAND THAT FOLLOWS ITS TRUE PASSION
THE LOVE FOR THE OCEAN.

WE ARE CONSCIOUS ADVENTURERS THAT NEVER CEASE TO BE AMAZED BY THE BEAUTY OF NATURE.

WE CELEBRATE LIFE EACH DAY BY LIVING WITH PASSION AND ADRENALINE.

WE INVITE YOU TO OUR JOURNEY, JOIN THE UNDERWATER REVOLUTION!.

BONASSI

INDEX

BCD's	12
Regulators	18
Gauges	22
Wetsuits	28
Masks	46
Goggles	56
Snorkels	60
Fins	66
Combos	74
Spearfishing	80
Knives	84
Spearfishing accessories	88
Diving accessories	100
Maintenance Tools	110

Created by @colleenflanigan in honor of Zoe Anderson, Zoe is a memorial coral restoration project combining art, science, & tech. With the goal of maintaining a coral restoration project in Cozumel the Mexican Caribbean island and today thanks to one of it's volunteer and today our ambassador @miri_adventures is still standing protecting marine fauna and promoting the care of the ocean.
 Photography @juanpopularcinema
 More on www.zoecoral.com



Saving Our Sharks is a non-profit organization with 12 years of experience in the Mexican Caribbean dedicated to the study and conservation of sharks. This organization, together with the diving community of Playa del Carmen, has positioned the activity of diving with bull sharks as an unprecedented conservation management experience. Here is a photo of Samuel our #underwaterrevolution ambassador who is an ally of Saving Our Sharks through his activism, through his participation as an attraction diver and as a conscious inhabitant of Playa del Carmen.
 Photography @jeleserenafusato_uwphoto
www.savingoursharks.org



S-BONASSI

UNDERWATER REVOLUTION

EVERY REVOLUTION STARTS BY DREAMING BIG.

FOR BONASSI THE REVOLUTION BEGINS WITH OUR DAILY ACTIONS SUPPORTING DIVERS, MARINE CONSERVATION NON-PROFIT ORGANIZATIONS, BIOLOGISTS, AND ATHLETES TO ACCOMPLISH THEIR MISSION.

OUR REVOLUTION IS TO BRING TO THE PRESENT DAY THE SAME PASSION OF OUR FATHERS', THE PIONEERS OF THE OCEAN AND FIRST EXPLORERS. WE ARE A FAMILY BUSINESS AND THERE ARE ONLY A FEW OF US LEFT IN RECREATIONAL DIVING. FOR US, DIVING IS A LIFESTYLE. WE ARE LIVING THE DREAM AND TOGETHER WITH OUR TEAM, DISTRIBUTORS, ATHLETES, AMBASSADORS AND CUSTOMERS, WE ARE MAKING IT A REALITY.

OUR ATHLETES



ROBERTO GUZMAN

-100 m deep
5x National Record



ALEJANDRO LEMUS

3X World Record
Deepest Mexican freediver 107m
73x National Records



MARCELA AVILA

2 Cmas Depth national records
2 pool Aida national records for Colombia.

OCEAN

ITALY

The majority of Bonassi– branded products are made by expert Italian artisans, whose craftsmanship and attention to detail have won the approval of the European community.

OUR HISTORY

In 1978, with the enthusiasm and passion of those who love the underwater world, the brothers Paolo and Piero Bonassi decide to open Punto Sub; a young Italian company focused on the purchase and sale of diving equipment.

Over the past 40+ years Punto Sub has grown from being one of the first diving centers in Europe to become a diving, spearfishing and swimming industry leader. In 2009, with the same passion and professionalism, the Bonassi brothers decided to expand to Mexico, capitalizing on the energy and dynamism of their sons, Alberto and Andrea.

FAMILY

PASSION

Thirty-one years later the experience of Punto Sub Italia and the vitality of Punto Sub México come together to shape a project capable of responding to the individual needs of each of their clients.

In 2018, Punto Sub launched its own brand of scuba diving equipment: **Bonassi.**

The strength of the Bonassi brand is based on the Bonassi family's forty-year history in the field of scuba diving, a history that has lived every step of the evolution of this industry almost since its birth. This vast experience has educated the Bonassi family, and their products reflect the best features available in the market while maintaining the company focus on original products specifically designed for the diving center, rental and snorkeling markets.



BONASSI

UNDERWATER REVOLUTION



1978
ITALY
Punto Sub
Torino

2009
MEXICO
Punto Sub s de rl de cv
Playa del Carmen

2019
DOMINICAN
REPUBLIC
Punto Sub Water Sports SRL
Punta Cana

2020
COSTA RICA
Bonassi Costa Rica

2021
UNITED STATES
Bonassi USA Inc.
Sarasota Florida



Bonassi is a registered trademark of Punto Sub S de RL de CV
Kombat, Doc, Koala, Kangu, Spider, Zephyr, Eolo, Orion, Virgo, Aries, Draco,
Vespucci, Morgan, Colombo, Ulisse, Maestro, Hera, Athena, Athena
Revo, Apollon, Artemis, Hercules, Juno, Jupiter, Mars, Aruba, Antigua, Cayo,
Barbados, Bahamas, Dominica, Martinica, Haiti, Marlin, Snapper,
Shark, Whale, Sea Fox, Orca, Anthias, Polo Hooded Vest, Caribe Glove, Metal
Socks, Metal Glove, Goliath, Sea Bass and Blue Roller Anthias and
Crab are trademarks of Punto Sub S de RL de CV

2023

BCD

PHOTOGRAPHY: @JUANPOPULARCINEMA

DURABLE MATERIALS AND EXPERT ITALIAN CRAFTSMEN COMBINE EXPERIENCE WITH THE HIGHEST STANDARDS TO OFFER YOU THE BEST BCDS FOR ALL YOUR DIVING NEEDS, FROM RENTAL EQUIPMENT TO HIGH-END BCD READY FOR ANYTHING.

   /BONASSI.OFFICIAL



KOMBAT



2023

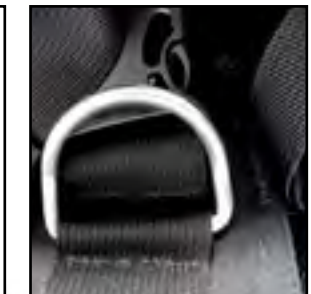
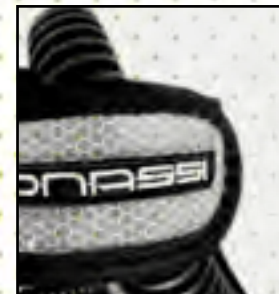

		Talla/ Size		
XXS	XS/S	M	L/XL	XXL
		Referencia/SKU		
CH445000	CH445001	CH445003	CH445004	CH445006

ES
 Material: cordura 1000 denarys externa, 500 denarys interna
 Banda ventral ajustable.
 Sistema de doble hebilla que cubre dos tallas en una
 Dos bolsillos para plomo laterales extraíbles con hebilla.
 Dos bolsillos laterales con cierre, amplios y con un bungee por dentro para poder enganchar accesorios
 Por de bajo del bolsillo izquierdo hay otro bolsillo telescópico que se abre con un clip.
 4 D-ring grandes y 2 D-ring pequeños en acero inoxidable AISI 304
 Tres porta accesorios en ambos lados para accesorios adicionales
 Inflador x01-tech
 3 válvulas de descarga rápida, una arriba del hombro derecho, una abajo de tras del chaleco lado derecho, una en la traquea.

EN
 Material; cordura 1000 denarys external, 500 denarys internal.
 Adjustable cummerbund
 Double buckle system that covers two sizes in one
 Two removable side weight pockets with buckles.
 Two large zippered side pockets with a bungee inside to hold accessories
 At the bottom of the left pocket there is another telescopic pocket
 4 large D-rings and 2 small D-rings in AISI 304 stainless steel
 On the sides two gray strips to hook more accessories
 inflator x01-tech.

   /BONASSI.OFFICIAL



KOALA

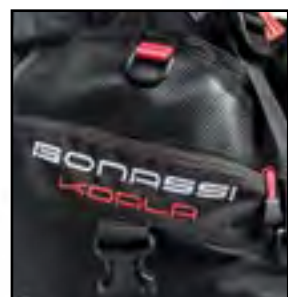

Talla/ Size				
XXS	XS/S	M	L/XL	XXL
Referencia/SKU				
CH115000	CH115001	CH115003	CH115004	CH115006

ES
 Material: Cordura 1000 externa alta tenacidad y Cordura 400 interna.
 Banda ventral ajustable.
 Sistema de doble hebilla en hombros que cubre dos tallas en una.
 Bolsillos para plomo laterales integrados.
 Dos valvulas de descarga rapida.
 Certificación CE.
 El inflador no tiene partes móviles que estén sujetas a desgaste. El resultado es una unidad de control segura, fácil de mantener y confiable que perdura en el tiempo. El aumento de las secciones de paso de aire y el rediseño del sistema han mejorado la capacidad de escape en más del 30%.
 Esta mejora cumple con los nuevos requisitos del mercado técnico a la luz de las regulaciones recientes.

EN
 Material: external high tenacity Cordura 1000 and inner Cordura 400.
 Adjustable cummerbund.
 Double buckle system in shoulders that gives you two sizes in one.
 Lateral pocket integrated system for leads.
 Two OP valves.
 CE certification.
 The inflator has no moving parts resulting in a safe, easy to maintain and reliable control that will last for many years.
 The increase of air passage sections and the system resizing have enhanced the exhaust capacity by over 30%.
 This improvement meets all the newest requirements for the technical diving market.



KANGU

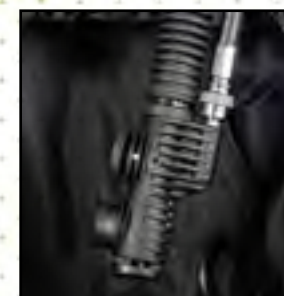

Talla/ Size				
XXS	XS/S	M	L/XL	XXL
Referencia/SKU				
CH225000	CH225001	CH225003	CH225004	CH225006

ES
 Bonassi Kangù es un chaleco ideal para los centros de buceos, las escuelas y el uso rudo.
 Es equipado con dos bolsillos laterales grandes que permiten un fácil acceso a cualquier equipo que pueda guardar en ellos.
 Material: Cordura 1000 externa alta tenacidad y Cordura 400 interna.
 Banda ventral ajustable.
 Sistema de doble hebilla en hombros que cubre dos tallas en una.
 Sistema de inflador con pivote.

EN
 Bonassi Kangù is the perfect BCD for the dive centers focussed on the rental market. It comes with two large pockets that allow easy access to hand-held items like lights, knives and gloves.
 Material: external high tenacity Cordura 1000 and inner Cordura 400.
 Adjustable cummerbund.
 Double buckle system in shoulders gives you two sizes in one.
 Inflator system with pivot.



DOC

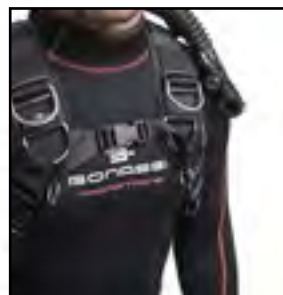

UNITALLA - NO SIZE

Referencia

CH225099

ES

El Doc viene preparado para un solo tanque y tiene un perfil largo y estrecho que soporta el tanque.

Capacidad: 30 lbs (13,6 kg)

Material: Cordura 1000

Arnes flexible sin placa con hebillas de plástico.

Anillos en D y accesorios Acero inoxidable AISI 304.

Certificación CE.

El inflador no tiene partes móviles que estén sujetas a desgaste.

El resultado es una unidad de control segura, fácil de mantener y confiable que perdura en el tiempo.

El aumento de las secciones de paso de aire y el rediseño del sistema han mejorado la capacidad de escape en más del 30%.

Esta mejora cumple con los nuevos requisitos del mercado técnico a la luz de las regulaciones recientes.

La manguera corrugada tiene una longitud de 340 mm y el material es epdm. Esto lo hace más suave y confortable.

EN

The Doc is designed for diving with a single tank.

It has a long, narrow profile to support the cylinder.

Capacity: 30 lbs (13,6 kg).

Material: Cordura 1000.

Soft plate with plastic buckles.

D-Rings and Accessories Stainless Steel AISI 304.

CE certification.

The inflator has no moving parts resulting in a safe, easy to maintain and reliable control that will last for many years.

The increase of air passage sections and the system resizing have enhanced the exhaust capacity by over 30%. This improvement meets all the newest requirements for the technical diving market.

The corrugated hose is 340mm length and the material is EPDM. This make it extra soft and comfortable

SPIDER
JUNIOR

JUNIOR

Referencia

CH335001

ES

Spider es un chaleco ideal para los niños que se acercan al buceo.

La vestibilidad es muy reducida y es perfecto para niños de 8

a 12 años.

Características técnicas:

Cordura 1000 denares.

Espaldera suave y confortable.

Dos válvulas de descarga rápida.

Dos cremalleras laterales y una frontal.

Faja ventral ajustable.

EN

The Spider BCD is perfect for children who are begining divers.

It offers an adjustable waistband and specially curved shoulder straps that provide a comfortable fit.

The small fit is perfect for children from 8 to 12 years old.

Technical characteristics:

Cordura 1000 denier.

Soft and comfortable shoulder.

Two OP valves.

Two side zippers and one front zipper.

Adjustable waistband



2023

PHOTOGRAPHY: @JUANPOPULARCINEMA

REGULATORS

PROUDLY DESIGNED AND MADE IN ITALY WITH THE HIGHEST STANDARDS FOR YOU.
OUR PASSION DRIVE US TO EXPLORE NEW POSSIBILITIES AND CREATING THE BEST GEAR.



f i y /BONASSI.OFFICIAL



ZEPHYR

2023



DIN

ZEPHYR REGULATOR DIN

Referencia/SKU

RP103411



YOKE

ZEPHYR REGULATOR YOKE

Referencia/SKU

RP103422



ES
Primera etapa con diafragma balanceado.
Simple, fuerte y confiable con presión intermedia constante.
Filtro cónico.
4 + 1 salidas de baja presión.
2 salidas de alta presión.
Sistema de sellado seco antifreeze.
Segunda etapa con excelente rendimiento en agua fría.
Anillo de seguridad de bloqueo de diafragma que garantiza el perfecto funcionamiento durante todas las fases.
Válvula de escape.
Control del efecto Venturi modalidad dive-predivo.
Tapa frontal suave.
Longitud de manguera de 730 mm.



EN
Balanced diaphragm first stage.
Simple, strong and reliable with constant intermediate pressure.
Conic filter.
4+1 low-pressure outlets.
2 high-pressure outlets.
Anti freeze dry seal system.
Second stage with excellent cold water performance.
Diaphragm block safety ring which assures better functionality during all phases.
Exhaust valve.
Venturi control lever with dive-predivo mode.
Soft front cover.
Hose length of 730 mm.

f i y /BONASSI.OFFICIAL



EOLO



DIN



YOKE

DIN	YOKE
Referencia/SKU	Referencia/SKU
RP080422	RP080422

ES
Primera etapa de pistón no balanceado.
Sencillo, fuerte, indestructible.
Filtro cónico.
4 salidas de baja presión.
1 salida de alta presión.
Segunda etapa con excelente rendimiento en agua fría.
Anillo de seguridad de bloqueo de diafragma que garantiza el perfecto funcionamiento durante todas las fases.
Válvula de escape.
Control del efecto Venturi modalidad dive-predivo.
Tapa frontal suave.
Longitud de manguera de 730 mm.

EN
Non-balanced piston first stage.
Simple, strong and indestructible.
Conic filter.
4 low-pressure outlets.
1 low-pressure outlet.
Second stage with excellent cold water performance.
Diaphragm block safety ring which assures better functionality during all phases.
Exhaust valve.
Venturi control lever with dive-predivo mode.
Soft front cover.
Hose length of 730 mm.



OCTOPUS EOLO



EOLO REGULATOR 2ND STAGE OCTOPUS
Referencia/SKU
RP200300

ES
Segunda etapa con excelente rendimiento en agua fría.
Anillo de seguridad de bloqueo de diafragma que garantiza el perfecto funcionamiento durante todas las fases.
Válvula de escape.
Control del efecto Venturi modalidad dive-predivo.
Tapa frontal suave.
Longitud de manguera de 1000 mm.

EN
Second stage with excellent cold water performance.
Diaphragm block safety ring for excellent functionality during all phases.
Exhaust valve.
Venturi control lever with dive-predivo mode.
Soft front cover.
Hose length of 1000 mm.



ZEPHYR FIRST STAGE ONLY



ZEPHYR REGULATOR DIN FIRST STAGE
Referencia/SKU
RP103111

ES
Primera etapa con diafragma balanceado.
Simple, fuerte y confiable con presión intermedia constante.
Filtro cónico.
4 + 1 salidas de baja presión.
2 salidas de alta presión.
Sistema de sellado seco antifreeze.



ZEPHYR REGULATOR INT/YOKE FIRST STAGE
Referencia/SKU
RP103122

EN
First stage with balanced diaphragm.
Simple, strong and reliable with constant intermediate pressure.
Conical filter.
4 + 1 low pressure outlets.
2 high pressure outlets.
Anti-freeze dry sealing system.

2023





PHOTOGRAPHY: @ELESEKENAFUSATO UWPHOTO

GAUGES

Whenever you need to trust your gear, we are there with you. Your instruments will keep your diving safe while you explore and enjoy the underwater life.



   /BONASSI.OFFICIAL

A POWERFULL RENTAL COMBINATION



SOLO
Octopus

SOLO INT
First and second stage

RENTAL
CONSOLE

BONASSI
KORALA
Rental BCD



   /BONASSI.OFFICIAL

VALE PRESSURE GAUGE PSI (WITH HOSE)



RENTAL PRESSURE GAUGE PSI RENTAL WITH HOSE



MINI CONSOLE TRIS 3 GAUGE (PSI/FEET)



BOURDON

Color

Black

Referencia/SKU

PSI: TER130036/S



EN
Manometer 3mm-2.5" with 32" HP hose 6.
1-piece brass body.
Inner mechanism: copper beryllium coiled;
Bourdon tube;
Rack and pinion movement for smooth and precise operation;
Polycarbonate transparent window;
Plastic / rubber cover with connecting loop.

ES
Manómetro 52mm -2" con manguera de HP 80cm.
Cuerpo de latón de una sola pieza;
Mecanismo interno: berilio de cobre enrollado;
Sistema a Tubo Bourdon;
Movimiento de piñón para un funcionamiento suave y preciso;
Tapa transparente de policarbonato;
Cubierta de plástico y goma con lazo para fijación.



Color
Black

Referencia/SKU

PSI/FEET: CVTRIS01

ES
Carcasa de caucho termoplástico reforzado. Compás angulado para correcta visión de la ventanilla durante la navegación. Cuadrante luminiscente y corona giratoria. Profundímetro con núcleo metálico y funcionamiento a membrana. Manómetro con dígitos muy visibles de gran tamaño. Esfera graduada de cero a 350 bares en segmentos de 10 bares. Segmentación especialmente amplia y precisa de 0 a 80 bares.

EN
Reinforced thermoplastic rubber housing. Angled compass for correct viewing of the window during navigation. Luminescent dial and rotating crown. Depth gauge with metal core and membrane operation. Manometer with highly visible and 32" large digits.. Graduated sphere from 0 to 350 bars in segments of 10 bars.



DOUBLE SCALE RENTAL CONSOLE 2 GAUGE (PSI-BAR/FEET-METERS)



RENTAL CONSOLE 2 GAUGE (PSI/FEET)



BOURDON

Color

Black

Referencia/SKU

CMPD



EN
Two elements rental consol PSI/FEET Y BAR/MTS
Manometer (SPG63)63mm-2.5"
1-piece brass body;
Inner mechanism: copper beryllium coiled;
Bourdon tube;
Rack and pinion movement for smooth and precise operation;
Polycarbonate transparent window;
Plastic-rubber cover with connecting loop.
Depth gauge (MDI63) 63 mm-2.5"
Copper Beryllium diaphragm;
340° degrees scale with wide reading in the first half of the scale;
Adjustable screw for altitude diving.
Luminous, easy-to-read dial.
Easy-to-read and reset, red maximum depth indicator. Easy-to-read and reset, red maximum depth indicator.

ES
Consola doble escala PSI/FEET Y BAR/MTS
Manómetro: (SPG63)63mm-2.5"
Cuerpo de latón de una sola pieza;
Mecanismo interno: berilio de cobre enrollado;
Sistema a Tubo Bourdon;
Movimiento de piñón para un funcionamiento suave y preciso;
Tapa transparente de policarbonato;
Cubierta de plástico y goma con lazo para fijación.
Profundímetro (MDI63) 63 mm-2.5"
Diafragma de Berilio de cobre;
Movimiento de piñón para un funcionamiento suave y preciso;
Escala de 340° grados con lectura amplia en la primera mitad de la escala;
Tornillo ajustable para bucear en altitud;
Luminoso diseño de dial fácil de leer;
Indicador rojo de máxima profundidad fácil de reiniciar.

Color
Black

Referencia/SKU

PSI/FEET: TER130033

ES
Consola de dos elementos PSI con manguera de 80cm
Manómetro: (SPG63)63mm-2.5"
Cuerpo de latón de una sola pieza;
Mecanismo interno: berilio de cobre enrollado;
Sistema a Tubo Bourdon;
Movimiento de piñón para un funcionamiento suave y preciso;
Tapa transparente de policarbonato;
Cubierta de plástico y goma con lazo para fijación.
Profundímetro (MDI63) 63 mm-2.5"
Diafragma de Berilio de cobre;
Movimiento de piñón para un funcionamiento suave y preciso;
Escala de 340° grados con lectura amplia en la primera mitad de la escala;
Tornillo ajustable para bucear en altitud;
Luminoso diseño de dial fácil de leer;
Indicador rojo de máxima profundidad fácil de reiniciar.

EN
Two gauge console PSI with 32" hose
Manometer (SPG63)63mm-2.5"
1-piece brass body;
Inner mechanism: copper beryllium coiled;
Bourdon tube;
Rack and pinion movement for smooth and precise operation;
Polycarbonate transparent window;
Plastic-rubber cover with connecting loop.
Depth gauge (MDI63) 63 mm-2.5"
Copper Beryllium diaphragm;
340° degrees scale with wide reading in the first half of the scale;
Adjustable screw for altitude diving.
Luminous, easy-to-read dial.
Easy-to-read and reset, red maximum depth indicator.

VALE CONSOLE 2 GAUGE (PSI/FEET)



Referencia
PSI/FEET: CVMP 01

ES
Consola de dos elememntos con manguera de 80cm ideal para uso recreativo
Carcasa de caucho termoplástico reforzado. Profundímetro con núcleo metálico y funcionamiento a membrana. Segmentación amplia muy precisa especialmente de las cuotas de 0 mt a 12 mt. Cuadrante luminiscente. Medidas Ø 50 mm x altura 24,5 mm. Manómetro con dígitos muy visibles de gran tamaño.

EN
Two gauge console with 32" hose—perfect for recreational use
Reinforced thermoplastic rubber housing. Depth gauge with metal core and membrane operation. Very precise wide segmentation, especially from 0 mt to 12 mt. Luminescent dial. Measurements Ø 50 mm x 24,5 mm. Manometer with highly visible and large digits.

EXTERNAL PRESSURE GAUGE PSI



Referencia/SKU
PSI: VEX01

PRESSURE GAUGE PSI (ONLY BODY)



BOURDON
Referencia/SKU
PSI:TER130039/NS

ES
Manometro Tecnico desnudo en acero niquelado. Diam.52mm-2". Vidrio templado. Sistema a tubo de bourdon mecánico. Diametro 63mm-2,5."

EN
Naked manometer Polycarbonate transparent window Diametro 63mm-2"

VALE PRESSURE PSI (ONLY BODY)



Referencia/SKU
PSI: VD01

COMPASS PRO



Referencia
TER130008

ES
Brújula Standard con correa de pulso y relleno de aceite. Diam. 60 mm / 2.3"

EN
Standard Compass Wrist model. Diam. 60 mm / 2.3"

SWIVEL FOR PRESSURE GAUGE + O RING



Juego
1 PZ. DE VASTAGO + O-RINGS
1 PC. SWIVEL + O-RINGS

Referencia
SWIVEL



Juego
10 PCS. PACK O-RINGS FOR SWIVEL

Referencia
ORSW

PRESSURE GAUGE -RENTAL PSI (ONLY BODY)



Referencia
PSI:TERSPPG63

ES
Manometro desnudo. Diam. 63mm-2.5". Sistema a tubo de bourdon mecánico.

EN
Naked manometer. Polycarbonate transparent window Diameter 63mm-2.5"



DEEP GAUGE -RENTAL FEET (ONLY BODY)



Referencia
FEET: TER130040/C

ES
Profundímetro desnudo de alto rendimiento . Diam. 63mm-2.5".

EN
High performance naked depth gauge. Diam: 63 mm / 2.5"



PHOTOGRAPHY: @JUANPOPULARCINEMA

WETSUITS

PROTECTION, COMFORT AND LONG LASTING WETSUITS.
FREE DIVING, SCUBA DIVING, SPEARFISHING.
1MM-2MM-3MM-5MM

   /BONASSI.OFFICIAL



A POWERFULL FREEDIVING COMBINATION



SAHAMAS
Blue Metal

APOLLON
Freediving mask

ORION
3mm open cell

SEERFOX
Freediving fins



   /BONASSI.OFFICIAL



ORION

3mm HOMBRE - MEN



Talla/Size				
S	M	L	XL	XXL
Referencia/SKU				
TN214001	TN214002	TN214003	TN214004	TN214005

ES Traje de 2 piezas, 3mm para hombre de dos piezas (pantalón y chaqueta), open cell por dentro que aumenta al máximo la flexibilidad y la protección térmica. Parche de nopreno y "Melco Tape" para facilitar el cargado del arpón. Especialmente diseñado para apnea y pesca submarina.

EN 3mm two-piece suit for men (pants and jacket), open cell inside that maximizes flexibility and thermal protection. Chest pad to assist in loading the speargun. Especially designed for free diving and spearfishing.



VIRGO

3mm MUJER - WOMEN

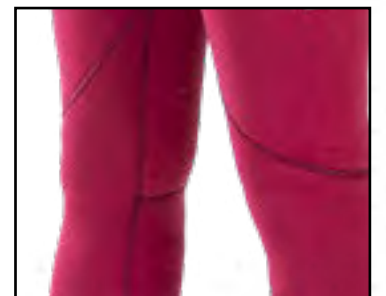
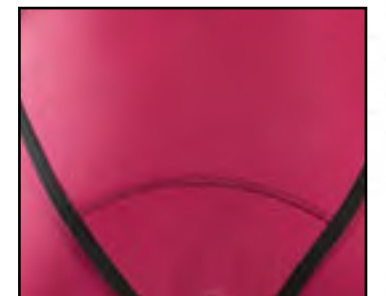

Talla/Size				
XS	S	M	L	XL
Referencia/SKU				
TP234000	TP234001	TP234002	TP234003	TP234004

ES Traje de 2 piezas, 3mm para mujer de dos piezas (pantalón y chaqueta), open cell por dentro que aumenta la flexibilidad y la protección térmica. Especialmente diseñado para apnea y pesca submarina.

EN 3mm two-piece suit for women, (pants and jacket) open cell inside that maximizes flexibility and thermal protection. Especially designed for free diving and spearfishing.



ARIES

2mm HOMBRE - MEN

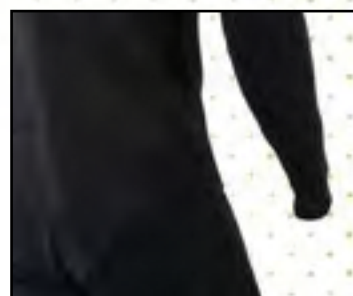
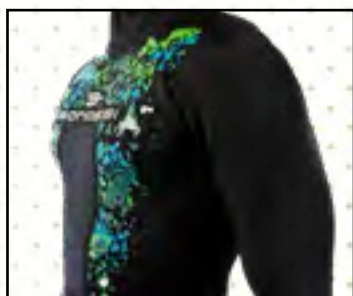

ULTRA SPAM DOUBLE RAYEL

Talla/Size			
S	M	L	XL
Referencia/SKU			
TO224001	TO224002	TO224003	TO224004

ES Traje de piezas, 2 mm para hombre de dos piezas (pantalón y chaqueta). ULTRASPAN por dentro y por fuera que aumenta al máximo la flexibilidad y la protección térmica. Pechera para facilitar el cargado del arpón. Especialmente diseñado para pesca submarina en aguas cálidas.

EN 2mm men's two-piece suit (pants and jacket) ULTRASPAN inside and out that maximizes flexibility and thermal protection. Chest patch to facilitate loading the speargun. Especially designed for spearfishing in warm waters.



DRACO

NEOPRENE + LYCRA



RASHGUARD

Talla/Size				
S	M	L	XL	XXL
Referencia/SKU				
TJ163001	TJ163002	TJ163003	TJ163004	TJ163005

ES La Draco es una rashguard pensada para los amantes de la pesca submarina en aguas cálidas. El área del torso es hecha de neopreno de 1mm para mayor protección térmica. Capucha y mangas en lycra. La Draco se puede usar también debajo de un traje de neopreno para dar más calor y protección. Doble parche de neopreno para facilitar el cargado del arpón.

EN The Draco rashguard is designed for spearfishing lovers. It is ideal for warm waters. The chest and back areas are made of 1mm neoprene for greater thermal protection with Lycra hood and sleeves. The Draco can also be worn under a wetsuit for extra warmth and protection. Double neoprene chest pad assist in loading the speargun.

PANTS

Talla/Size			
S	M	L	XL
Referencia/SKU			
TK173001	TK173002	TK173003	TK173004



VESPUCCI

5mm HOMBRE - MEN

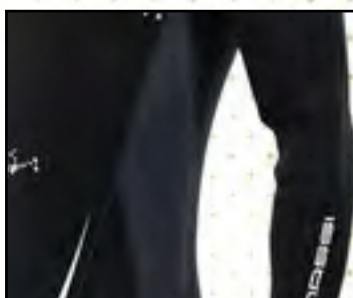
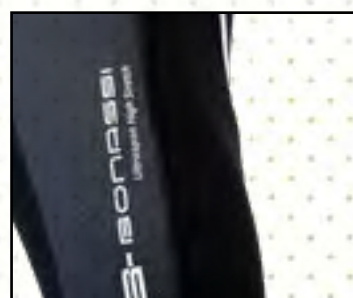

ULTRA STRETCH

Talla/Size					
XS	S	M	L	XL	XXL
Referencia/SKU					
T1145500	T1145501	T1145502	T1145503	T1145504	T1145505

ES
Traje de neopreno de 5.0 mm de una pieza ideal para la renta y uso rudo. La cremallera trasera YKK tiene un Aqua Stop debajo de la cremallera y un velcro especial que no daña el traje. Parches especiales en hombros y rodillas para protección adicional que están sujetos a alto desgaste.

Tiene dos insertos en neopreno ultraspan que corren a lo largo los costados del traje para mayor comodidad y para facilitar la puesta y los movimientos abajo y afuera del agua. Especialmente diseñado para Centros de Buceo, Compañías de Tours, Instructores y un fuerte uso diario.

EN
All-in-one 5.0 mm neoprene wetsuit ideal for rental and rough use. Back YKK zipper with an Aqua stop under the zipper and special connector strap that does not damage the wetsuit. Special Patches in shoulders and knees for extra protection in the high stress areas.

It has two ultraspan neoprene inserts that run along the sides of the suit for greater comfort, to facilitate putting it on, and for better mobility in and out of the water. Specially designed for Diving Centers, Tour Companies, instructors and recreational / daily divers.



VESPUCCI

5mm MUJER - WOMEN

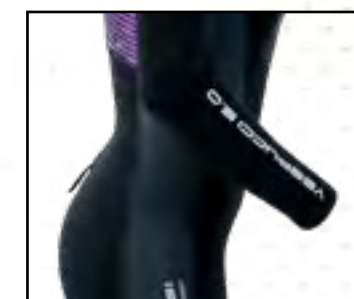

ULTRA STRETCH

Talla/ Size					
XXS	XS	S	M	L	XL
Referencia/SKU					
T1152599	T1152500	T1152501	T1152502	T1152503	T1152504

ES
Traje de neopreno de 5.0 mm de una pieza ideal para la renta y uso rudo. La cremallera trasera YKK tiene un Aqua Stop debajo de la cremallera y un velcro especial que no daña el traje. Parches especiales en hombros y rodillas para protección adicional que están sujetos a alto desgaste.

Tiene dos insertos en neopreno ultraspan que corren a lo largo los costados del traje para mayor comodidad y para facilitar la puesta y los movimientos abajo y afuera del agua. Especialmente diseñado para Centros de Buceo, Compañías de Tours, Instructores y un fuerte uso diario.

EN
All-in-one 5.0 mm neoprene wetsuit ideal for rental and rough use. Back YKK zipper with an Aqua stop under the zipper and special connector strap that does not damage the wetsuit. Special Patches in shoulders and knees for extra protection in the high stress areas.

It has two ultraspan neoprene inserts that run along the sides of the suit for greater comfort, to facilitate putting it on, and for better mobility in and out of the water. Specially designed for Diving Centers, Tour Companies, instructors and recreational / daily divers.



MORGAN

3mm HOMBRE - MEN

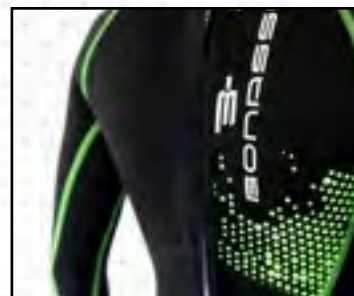

Talla/Size					
XS	S	M	L	XL	XXL
Referencia/SKU					
TH125500	TH125501	TH125502	TH125503	TH125504	TH125505

ES Traje de neopreno de 3 mm de una pieza ideal para la renta y uso rudo. La cremallera trasera YKK tiene un Aqua Stop debajo de la cremallera y un velcro especial que no daña el traje. Parches especiales en hombros y rodillas para protección adicional que están sujetos a alto desgaste. Ideal para aguas tropicales. Especialmente diseñado para Centros de Buceo, Compañías de Tours, Instructores y un fuerte uso diario..

EN All-in-one 3 mm neoprene wetsuit ideal for rental and rough use. Back YKK zipper has an Aqua stop under the zipper and special velcro that does not damage the wetsuit. Special Patches in shoulders and knees for extra protection in the high stress areas. Ideal for tropical waters. Specially designed for Diving Centers, Tour Companies and recreational / daily use.



MORGAN

3mm MUJER - WOMEN



Talla/Size					
XXS	XS	S	M	L	XL
Referencia/SKU					
TH132599	TH132500	TH132501	TH132502	TH132503	TH132504

ES Traje de neopreno de 3 mm de una pieza ideal para la renta y uso rudo. La cremallera trasera YKK tiene un Aqua Stop debajo de la cremallera y un velcro especial que no daña el traje. Parches especiales en hombros y rodillas para protección adicional que están sujetos a alto desgaste. Ideal para aguas tropicales. Especialmente diseñado para Centros de Buceo, Compañías de Tours, Instructores y un fuerte uso diario..

EN All-in-one 3 mm neoprene wetsuit ideal for rental and rough use. Back YKK zipper has an Aqua stop under the zipper and special velcro that does not damage the wetsuit. Special Patches in shoulders and knees for extra protection in the high stress areas. Ideal for tropical waters. Specially designed for Diving Centers, Tour Companies and recreational / daily use.



COLOMBO

3mm HOMBRE - MEN

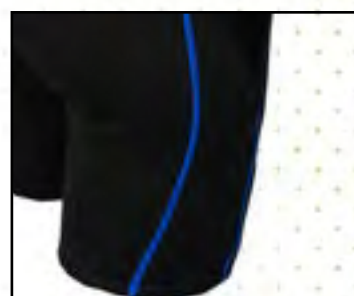
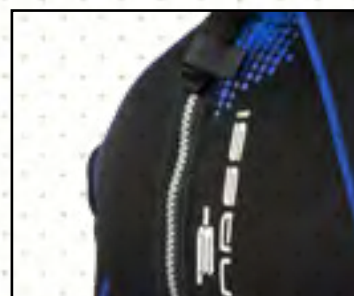

Talla/Size						
XS	S	M	L	XL	XXL	XXXL
Referencia/SKU						
TQ245000	TQ245001	TQ245002	TQ245003	TQ245004	TQ245005	TQ245006

ES
Traje de neopreno corto de 3 mm.
Cremallera trasera YKK.
Cierre anatómico de cuello.
Velcro especial que no daña el traje de neopreno.
Perfecto para practicar snorkeling, inmersiones en aguas tropicales y deportes acuáticos en general.
Especialmente diseñado para Centros de Buceo, Compañías de Tours, Instructores y un fuerte uso diario.

EN
Shorty 3 mm neoprene wetsuit.
Back YKK zipper.
Anatomic cut neck closure.
Special connector strap that does not damage the wetsuit.
Perfect for snorkeling, dives in tropical waters and water sports in general.
Specially designed for Diving Centers, Tour Companies and recreational / daily use.



COLOMBO

3mm MUJER - WOMEN



Talla/Size					
XXS	XS	S	M	L	XL
Referencia/SKU					
TQ242099	TQ242000	TQ242001	TQ242002	TQ242003	TQ242004

ES
Traje de neopreno corto de 3 mm.
Cremallera trasera YKK.
Cierre anatómico de cuello.
Velcro especial que no daña el traje de neopreno.
Perfecto para practicar snorkeling, inmersiones en aguas tropicales y deportes acuáticos en general.
Especialmente diseñado para Centros de Buceo, Compañías de Tours, Instructores y un fuerte uso diario.

EN
Shorty 3 mm neoprene wetsuit.
Back YKK zipper.
Anatomic cut neck closure.
Special connector strap that does not damage the wetsuit.
Perfect for snorkeling, dives in tropical waters and water sports in general.
Specially designed for Diving Centers, Tour Companies and recreational / daily use.



ULISSE

3mm HOMBRE - MEN

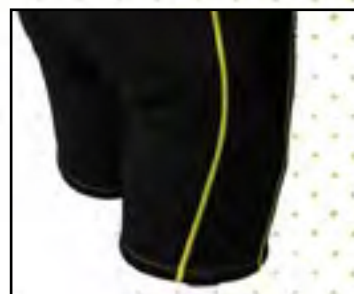
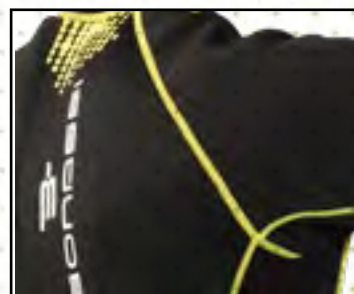
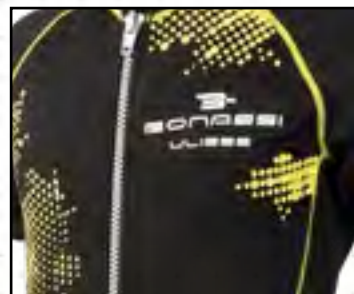

A POWERFULL COMBINATION



APOLLON
Freediving mask

RASHGUARD
UV 40+

SEEPFOX
Freediving Fins

		Talla/Size							
		JUNIOR	XS	S	M	L	XL	XXL	XXXL
		Referencia/SKU							
		TG105099	TG105000	TG105001	TG105002	TG105003	TG105004	TG105005	TG105006

ES
Traje de neopreno corto de 3 mm.
Cremallera frontal YKK.
Cierre anatómico de cuello.
Perfecto para practicar snorkeling, inmersiones en aguas tropicales y deportes acuáticos en general.
Especialmente diseñado para Centros de Buceo, Compañías de Tours, Instructores y un fuerte uso diario.

EN
Shorty 3 mm neoprene wetsuit.
Front YKK zipper.
Anatomic cut neck closure.
Perfect for snorkeling, dives in tropical waters and water sports in general.
Specially designed for Diving Centers, Tour Companies and recreational and daily use.



LYCRA UV40+

MUJER - WOMEN



Talla/Size				
XS	S	M	L	XL
Referencia/SKU				
CR170201	CR170202	CR170203	CR170204	CR170205

LYCRA UV40+

HOMBRE - MEN



Talla/Size				
S	M	L	XL	XXL
Referencia/SKU				
CR170101	CR170102	CR170103	CR170104	CR170105

POLO HOODED VEST

3/5 mm HOMBRE - MEN



OPEN CELL INSIDE WITH A METALLITE LAYER EASY TO PUT ON

Talla/Size				
S	M	L	XL	XXL
Referencia/SKU				
TR253001	TR253002	TR253003	TR253004	TR253005

LYCRA UV40+

JUNIOR



Talla/Size		
S	M	L
Referencia/SKU		
CR170301	CR170302	CR170303

ES
Orgullosamente diseñadas y hechas en México.
Costuras hechas con sistema Flat-Lock.
Material original de lycra + Nylon más resistente que el poliéster.
Ideal para todos los deportes acuáticos.
Protección solar UV 40+.

EN
Proudly made and designed in Mexico.
Flat-Lock system seam.
Original material made of Lycra + Nylon, more resistant than polyester.
Ideal for all the aquatic sports.
UV 40+ Solar protection.

ES
Chaleco de 3mm con capucha integrada de 5mm. Celda abierta por dentro con cubrimiento en metalite para facilitar la puesta.

EN
Hooded 3/5mm vest. Open cell inside with a metalite layer to make it easier to put it on and remove.

METAL GLOVE

DIVING 3mm



Talla/Size		
XS/S	M/L	XL/XXL
Referencia/SKU		
TM203000	TM203002	TM203004

ES
El metal glove es un guante de 3mm ultraspan por dentro y por fuera. Este tejido proporciona una gran elasticidad y comodidad, dando la posibilidad de utilizar los dedos con total libertad de movimiento. La superficie de la palma está hecha con revestimiento antideslizante y tela resistente a las rayaduras. Ideal para el buceo en agua fría, dada su alta potencia térmica.

EN
The metal glove is a 3mm ultraspan glove. This fabric provides great elasticity and comfort, allowing complete freedom and use of the fingers. The palm surface is made with non-slip coating and scratch-resistant fabric. Ideal for diving in cold water, given its high thermal characteristics.



MAESTRO BOOTS

5mm



ES
Bota de neopreno 5 mm para aletas ajustables. Suela rígida antiderrapante. Extensa cremallera para una mayor comodidad de uso. Soporte en talón para las aletas.

EN
5 mm neoprene boot for open heel fins. Antislip rigid sole. Long zipper for a better use comfort. Support in the heel designed for the fins.

Talla/Size								
5/36	6/37.5	7/39	8/40.5	9/42	10/43	11/44.5	12/46	13/47
Referencia/SKU								
BA150005	BA150006	BA150007	BA150008	BA150009	BA150010	BA150011	BA150012	BA150013

CARIB GLOVE

SPEARFISHING 1.5mm



Talle/Size			
S	M	L	XL
Referencia/SKU			
TM193001	TM193002	TM193003	TM193004

ES
El Carib es un guante de 1.5mm comodo y resistente, especialmente diseñado para la pesca submarina. La superficie de la palma está hecha con revestimiento antideslizante y tela resistente a las rayaduras. velcro en la muñeca para un fácil ajuste.

EN
The Carib is a comfortable and resistant 1.5mm glove, especially designed for spearfishing . The palm surface is made with non-slip coating and scratch-resistant fabric. With a connector strap at the wrist for easy adjustment.

METAL SOCKS

2mm



ES
EL metal es un calcetín muy suave y flexibles hecho de neopreno elástico de 2 MM. Por dentro es neopreno celda abierto recubierto de Black metalite para facilitar la puesta y con suela antiderrapante.

EN
The metal sock is very soft and flexible, made of 2MM stretch neoprene. Inside it has open cell neoprene coated with black metalite to facility easy use. The socks have non-slip soles.

Talle/Size			
S	M	L	XL
Referencia/SKU			
TL183001	TL183002	TL183003	TL183004

HOOD

3 AND 5 mm



Talle/Size			
S	M	L	XL
Referencia/SKU			
TF093002	TF093003	TF093004	TF093005

EN
5 mm neoprene hood. This hood allows the head to move freely without water entering. Easy to wear.

ES
Capucha de neopreno 5 mm ideal para aguas frías. Permite mover libremente la cabeza sin que entre agua.

#UNDERWATERREVOLUTION



PHOTOGRAPHY: @TIAMJAVIERSANROMAN

MASKS

EXPLORING IS OUR PASSION, YOU CAN FIND THE PERFECT MASK MATCH FOR YOU, FREEDIVING, SCUBA DIVING, SNORKELING OR FOR YOUR RENTAL OPERATION. COMFORT AND RESISTANCE IS THE SOUL OF OUR MASKS.



A POLLON



Color	
BLACK/BLACK	BLUE/METAL
Precio/Price	
VT515050	VT519020



Color	
BLACK/MIRROR	
Referencia/SKU	
VT515090	

ES
 La máscara Apollon es pensada para apneistas y pescadores submarinos. Es utilizada por profesionales para entrenar en apnea profunda incluso a más de 50 metros de profundidad.
 Máscara de silicon con tecnología sin marco.
 Volumen interno súper reducido.
 Diseñada para ofrecer un volumen extremadamente bajo y la vista más amplia posible.
 Las hebillas giratorias tienen regulación micrométrica.
 Vidrio templado y correa anatómica.

EN
 Apollon mask is designed for advanced freediving and spearfishing. It is used by professionals freedivers for training deep freediving when deeper than 50 mts.
 Silicon mask with frameless technology.
 Super reduced internal volume.
 Designed to offer an extremely low volume and the widest view.
 The swiveling buckles feature micrometrical regulation.
 Tempered glass and anatomical strap.
 Includes rigid reusable box.

HERCULES



REVO

Color
Black Revo
Referencia/SKU
VT315090



ATHENA



Color
CAMU BLUE WHITE/CAMU PINK
Precio/Price
VT718020 VT715080

COLORS



BLACK/BLACK



RED



METAL BUE



BLACK/BLUE



BLACK/YELLOW



BLACK/RED



BLACK/BLACK

ES
Visor de silicón con tecnología frameless.
Hebillas completamente basculantes de regulación inmediata.
Incluye caja rígido reutilizable.

Color
BLACK/BLACK RED METAL BLUE
Precio/Price
VT315050 VT318070 VT319020

EN
Silicon mask with frameless technology.
Tilting buckles with immediate regulation.
Includes rigid reusable box.

ES
Distancia reducida entre las lentes y los ojos.
Amplio campo de visión.
Ligera pesa solo 161g.
Se adapta a todas las ca-

Color
CAMU BLUE BLACK/YELLOW BLACK/RED BLACK/BLACK
Precio/Price
VT715021 VT715010 VT715070 VT715050

EN
Reduced distance between lenses and eyes.
Ample field of vision.
Weight only 161g.
It fits everyone.

HERA



RED



ATHENA REVO

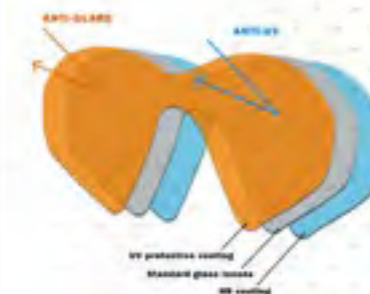

BLACK/RED

ES
Distancia reducida entre las lentes y los ojos.
Amplio campo de visión. Ligera pesa solo 161g. Se adapta a todas la caras. El visor Athena Revo reduce el reflejo, filtra los rayos UV y aumenta la profundidad de campo.
El acabado Revo permite a luz de pasar y aumenta la definición de los objetos bajo el agua.
El acabado azul interno reduce el cansancio de ojos y es muy confortable.
Incluye box rígido reutilizable.

Color	
BLACK	BLACK/RED
Precio/Price	
VT715090	VT718090

EN
Reduced distance between lenses and eyes.
Ample field of vision. Weight only 161g. It fits everyone.
Athena REVO mask reduce glare, block harmful UV rays and increase depth perception.
Because REVO lens coatings allows the light to pass through the diver gets HD vision.
Inside coating is a blue tint that reduces eyes strain for very comfortable viewing..
Includes rigid reusable box



BLACK



RED



BLUE

ES
Distancia reducida entre las lentes y los ojos.
Amplio campo de visión.
Ligera pesa solo 161g.
Se adapta a todas las caras.

Color			
RED	BLACK	WHITE	BLUE
Precio/Price			
VT107070	VT105050	VT102626	VT102020

EN
Reduced distance between lenses and eyes.
Ample field of vision.
Weight only 161g.
It fits everyone.
Includes rigid reusable box

ARTEMIS



ES
Distancia reducida entre las lentes y los ojos.
Amplio campo de visión.
Ligera pesa solo 161g.
Se adapta a todas la caras.
Soporte para cámara GoPro integrado.
Incluye caja rígida reutilizable.

Color	
BLACK	
Referencia/SKU	
VT615050	

EN
Reduced distance between lenses and eyes.
Ample field of vision.
Weight only 161g.
It fits everyone.
Integrated support assembly for GoPro.
Includes rigid reusable box.

JUNO



BLACK/YELLOW

COLORS



BLACK/BLACK



BLACK/BLUE



CLEAR/PINK



CLEAR/YELLOW

SINGLE UNIT

Color				
BLACK/YELLOW	BLACK/BLACK	BLACK/BLUE	CLEAR/PINK	CLEAR/YELLOW
Referencia/SKU				
VR115010	VR115050	VR115020	VR110040	VR110010

BULK 10 PACK

Referencia/SKU
VR115050X10

ES
Visor de silicon fuerte y robusto ideal para la renta y uso rudo.
Volumen interno reducido.
Disponibles refacciones y repuestos.
Incluye caja rígida reutilizable.

EN
Strong and robust silicon mask ideal for rental and daily / recreational use.
Reduced internal volume.
Replacement parts available.
Includes rigid reusable box.



JUPITER



BULK 10 PACK

Referencia/SKU
VR015050X10

SINGLE UNIT

Referencia/SKU
VR015050

ES
Visor de silicon fuerte y robusto ideal para la renta y uso rudo.
Se puede desensamblar para ser reparado.
Disponibles refacciones y repuestos.

EN
Strong and robust silicon mask ideal for rental and daily / recreational use.
It can be disassembled for repairs.
Replacement parts available.

NEREA



SINGLE UNIT

Referencia/SKU
VS195050

ES
Visor en silicon con válvula de purga. Un solo cristal templado frontal y dos cristales templados laterales que mejoran el campo visibilidad.

EN
Silicone mask with purge valve. A single front tempered glass and two side tempered glasses that improve the field of vision.



JUVENTAS JUNIOR



BLACK/BLACK



BLACK/ORANGE



CLEAR PINK



CLEAR BLUE

SINGLE UNIT

Color		Color	
BLACK/BLACK	BLACK/ORANGE	CLEAR/PINK	CLEAR/BLUE
Referencia/SKU		Referencia/SKU	
VJ215050	VJ215022	VJ210040	VJ210020

BULK 10 PACK

Color	
BLACK/BLACK	BLACK/ORANGE
Referencia/SKU	
VJ215050X10	VJ215022X10

ES
Visor de silicón fuerte y robusto ideal para la renta. Ideal para niños y adultos de cara pequeña. Disponibles refacciones y respuestos.

EN
Strong and robust silicon mask ideal for rental. Perfect for children and adults with a small face. Replacement parts available.

FULL VISION



Talla//Size		
XS	M	L / XL
Referencia/SKU		
FF062001	FF062002	FF062003

ES
Respira cómodamente con la Full Vision. Pensada y diseñada para ofrecer el mejor confort y seguridad, la Full Vision es fácil de ajustar y está hecha con suave silicona hipoalergénica. Tiene una válvula de purga de un solo sentido y como no tiene boquilla tradicional, no tienes que lidiar con la fatiga de morderla.
Características:
Fácil de respirar, el Smart Snorkel tiene un sistema de doble cámara que separa el aire fresco inhalado del CO2 exhalado, lo que garantiza que no se vuelva a respirar su propio CO2 exhalado, y solo estará respirando el aire fresco a su alrededor. Visibilidad panorámica de 180° y un diseño que hace que la máscara no se empañe. Esto es posible porque boca y nariz están aislados de la parte superior donde se encuentran los ojos. El esnorquel seco hace que no entre agua involuntariamente. Falda y correas de silicona.

EN
Breathe comfortably, with the Bonassi Full Vision Snorkeling Mask. Designed to offer the best comfort and safety, the full face snorkeling mask is easy to adjust with soft hypoallergenic silicone. It has a one-way purge valve and since it has no mouthpiece, you don't have to deal with jaw fatigue.
Features:
Easy to Breathe the Smart Snorkel has a dual chamber system that separates inhaled fresh air from exhaled CO2, ensuring that you don't rebreathe your own exhaled CO2, and are only breathing the fresh air around you.
180° Panoramic Visibility and fog-free design allows you to see and breathe underwater as you do on land.
Dry-top snorkel. Silicone Skirt and Straps.

GOGGLES



PHOTOGRAPHY: @JUANPOPULARCINEMA

SWIMMERS OF ALL AGES CAN ENJOY WATER ACTIVITIES WITH OUR ERGONOMIC GOOGLES DESIGNED TO FIT IN A COMFORTABLE WAY SO YOU CAN ENJOY WATER ACTIVITIES AS WE DO.

GOGGLE MASTER



ES
Goggle para la natación, entrenamiento y nado en aguas abiertas.
Ancho campo visual hasta 180 grados.
Apto para triatlón, jet-ski, kite surf y muchos mas deportes acuáticos.
Lentes de alta resistencia con tratamiento contra los rayos UVA y tratamiento interno antiempañado.
Hebillas regulables al milímetro.
Especial embalaje.

Color
BLACK/RED
Referencia/SKU
GS835070

EN
Great goggle for swimming, training and open water swimming.
180 degree view lens.
Perfect for many water sports such as triathlons, jet-skis or kite surfing. Unbreakable lens with special Anti-UV and anti fog treatment. Quick release buckles.
Special case packaging.

GOGGLE SWIMMER ADULT



BLACK/BLACK

CLEAR/BLUE

BLACK/GREEN

ES
Goggles de adulto aptos para clases de natación gracias a su facilidad de ajuste.
Lente ligeramente curvada hacia la parte exterior para ofrecer la máxima visibilidad.
Fácil de ajustar rápidamente a través de hebillas que permiten su ajuste milimétrico.
Tratamiento antiempañante.
Tratamiento anti UVA.
Caja rígida de plástico reutilizable.

Color			
BLACK/RED	BLACK/BLACK	CLEAR/BLUE	BLACK/GREEN
Referencia/SKU			
GS055070	GS055050	GS050020	GS055030

EN
These goggles, designed for adults, are ideal for swimming because of the easy adjustment feature.
With slightly, exterior curved lenses, these goggles offer the maximum visibility.
Easy to adjust quickly through the millimetric adjustment buckles.
Antifog treatment.
Anti UVA treatment.
Rigid reusable plastic box.

GOGGLE OPEN

JUNIOR



ES
Goggle para niños ideal para la natación, el entrenamiento y el nado en aguas abiertas.
Ancho campo visual hasta 180 grados.
Apto para muchos mas deportes acuáticos.
Lentes de alta resistencia con tratamiento contra los rayos UVA y tratamiento interno antiempañado.
Hebillas regulables al milímetro.
Especial embalaje.

Color
BLACK/GREEN
Referencia/SKU
GJ823024

EN
Great Jr. goggle ideal for swimming, training and open water swimming.
180 degree view lens.
Perfect for many water sports.
Unbreakable lens with special Anti-UV and anti fog treatment.
Quick release buckles.

A POWERFULL COMBINATION



HERCULES
Blue Metal

ARUBA
Freediving mask

HERO
Full vision mask

CAPO
Snorkel

GOGGLE DIVERS

JUNIOR



ES
Goggles de niño aptos para clases de natación gracias a su facilidad de ajuste.
Lente ligeramente curvada hacia la parte exterior para ofrecer la máxima visibilidad.
Fácil de ajustar rápidamente a través de hebillas que permiten su ajuste milimétrico.
Tratamiento antiempañante.
Tratamiento anti UVA.
Caja rígida de plástico reutilizable.

Color		
CLEAR/GREEN	BLACK/RED	CLEAR/PINK
Referencia/SKU		
GJ150030	GJ155070	GJ150040

EN
Goggles for kids ideal for swimming classes.
Because of the easy adjustment feature, these goggles are perfect for children learning to swim.
Slightly curved lens towards its exterior that offers maximum visibility.
Easy to adjust quickly through the millimetric adjustment buckles.
Antifog treatment.
Anti UVA treatment.
Rigid reusable plastic box.



SNORKELS



PHOTOGRAPHY: @JUANPOPULARCINEMA

EXPLORING IS OUR PASSION, BEING IN CONTACT WITH THE OCEAN AND ALL IT'S CREATURES TO DISCOVER AND ENJOY THE BEAUTY OF THE WORLD. OUR SNORKELS ARE DESIGN FOR ALL UNDER-WATER ACTIVITIES, FROM FREEDIVING, SCUBA-DIVING, SPEARFISHING TO RECREATIVE SNORKELING.

ARUBA



ES
Tubo con válvula de descarga rápida totalmente seco con sistema dry.
El sistema dry es un mecanismo que permite el total e instantáneo cierre del tubo para evitar la entrada de agua.
Boquilla de silicón.
Clip para visor con sistema de desenganche rápido.

	Colores/Colors	
PINK/CAMU	BLACK/BLUE	BLACK
Referencia/SKU	SS725020	SS725050
SS725080		



EN
Snorkel with quick purge valve with dry system.
The dry system is a mechanism that allows total and instantaneous closing of the tube to avoid water entry.
Silicon mouthpiece.
Clip for mask with quick release system.

ANTIGUA



BLACK/YELLOW

ES
Tubo con válvula de descarga rápida.
El sistema semi dry ayuda a reducir la entrada de agua en el tubo.

	Colores/Colors	
BLACK/YELLOW	BLACK/RED	BLACK/SKY BLUE
Referencia/SKU	SS075070	SS075070
SS075010		SS075070



BLACK/RED



BLACK/SKY BLUE

EN
Snorkel with quick purge valve.
The semy-dry system helps to reduce the water entry.
Silicon mouthpiece.
Clip for mask with quick release system.

CAYO



ES
Tubo de snorkel semi-regid.
Retenedor de snorkel de una pieza.
Moldura de silicona en forma de J con

Colores/Colors			
BLACK	WHITE	BLUE	RED
Referencia/SKU			
SS345050	SS342626	SS342020	SS348070

EN
Semi-regid snorkel tube.
One-piece snorkel retainer.
J-shaped silicone mouthpiece with purge.



MARTINICA



BULK 10 PACK
Referencia/SKU
SP025050X10

SINGLE UNIT
Referencia/SKU
SP025050

ES
Tubo fuerte y robusto. Ideal para uso rudo.
Boquilla de PVC suavizado.
Resiste a las peores mordidas.
Disponibles refacciones y repuestos.

EN
Strong and robust snorkel. Ideal for daily use.
Softened PVC mouthpiece.
Resistant to the worst bites.
Replacement parts available.



BARBADOS



HAITI JUNIOR

BULK 10 PACK
Referencia/SKU
SS625050X10



SINGLE UNIT
Referencia/SKU
SS625050

ES
El Barbados es un tubo semi seco.
La parte superior semiseca está diseñada para reducir el agua entrante y la válvula de purga rápida ayuda a que el agua salga.
El conector de silicona hace que este snorkel sea ideal para buzos, snorkelers o freedivers.
Clip para máscara con sistema de desganche rápido y boquilla de silicon.

EN
The Barbados is a semi-dry snorkel.
The semi-dry top is designed to reduce the incoming water and the quick purge valve helps the water escape.
The silicon connector makes this snorkel ideal for divers, snorkelers or freedivers.
Clip for mask with quick release system and silicon mouthpiece.

BULK 10 PACK
Referencia/SKU
SJ225050X10



SINGLE UNIT
Referencia/SKU
SJ225050

ES
Tubo con válvula para niños. Ideal para la renta.
Boquilla en silicon.
Refacciones y repuestos disponibles.

EN
Snorkel with valve for kids. Ideal for rental.
Silicon mouthpiece.
Replacements parts available.



BAHAMAS

FREEDIVING/SPEARFISHING



BLACK	BLUE/CAMU	METAL BLUE
Referencia/SKU		
SS325050	SS428020	SS329020

ES
Tubo para apnea de silicon. Muy suave, ideal para la apnea y pesca submarina. Proporciona una comodidad extrema durante un uso prolongado. Ideal para ser usado debajo de la correa de la máscara, todos los pescadores submarinos o los apneistas buscando el snorkel Bahamas por su flexibilidad y comodidad.

EN
Flexible silicon freediving snorkel. Super soft, ideal for freediving and spearfishing. Provides extreme comfort during prolonged use. Ideal to be wear under the mask's strap spearfishers and freedivers throughout the Bahamas love this snorkel for its flexibility and comfort.

A POWERFULL COMBINATION



HERA Diving Mask



CP40 Snorkel



MARLIN White Fins



DOMINICA

FREEDIVING/SPEARFISHING



Referencia/SKU
SS625050

ES
Tubo flexible de diametro largo, ideal para la apnea. Es completamente flexible y de silicon. Proporciona una comodidad extrema durante un uso prolongado. Ideal para ser usado debajo de la correa de la máscara.

EN
Large diameter and flexible silicon freediving snorkel. Super soft, ideal for freediving and spearfishing. Provides extreme comfort during prolonged use. Ideal to be wear under the mask's strap



GO DEEPER



PHOTOGRAPHY: @TRAVIS_XANDER

WWW.BONASSI.IT

FINIS

COMFORT, RESISTANCE AND DURABILITY. THIS IS THE WAY WE GET TO EXPLORE THE DEPTHS.
WE DESIGN AND CREATE FINIS FOR SNORKELING, DIVING, FISHING AND FREEDIVING SO YOU JUST
FOCUS ON GETTING BETTER EVERY TIME.



SEA FOX



Color
BLUE CAMU
Talla/Size

UE: 38/39	UE: 40/41	UE: 42/43	UE: 44/45	UE: 46/47
AT547138	AT547140	AT547142	AT547144	AT547146

Color
BLACK
Talla/Size

UE: 38/39	UE: 40/41	UE: 42/43	UE: 44/45	UE: 46/47
AT445038	AT445040	AT445042	AT445044	AT445046

ES

La aleta Bonassi Sea Fox es una aleta de plástico de pala larga diseñada con una hoja suave pero reactiva que hace que la Sea Fox sea una elección perfecta para todos los niveles de apneístas y pescadores submarinos. Son ideales para larga distancia y brindan la potencia y la eficiencia necesarias para el buceo profundo de apnea o pesca submarina. La Sea Fox está construida pensando en la durabilidad, por lo que es perfecta para instructores y alumnos que toman clases de apnea. La eficiencia y comodidad del calzante es derivada de una mezcla de compuestos que se unen para brindar flexibilidad en el área del pie. De hecho, esas aletas se pueden usar con o sin calcetines de neopreno. El calzante tiene una lengüeta grande en el talón para ponérselo y quitárselo con facilidad.

EN

The Bonassi Sea Fox freediving fin is a plastic long blade fin designed with a soft but reactive blade which makes it a perfect choice for all levels of freedivers. They are ideal for long distance swimming, while ultimately providing the power and efficiency needed for deep freediving and spearfishing. The Sea Fox is constructed with durability in mind and therefore is ideal for freediving courses and instructors. Special attention was put to the foot pocket to provide maximum comfort and efficiency in the foot area. They are so comfortable that they can be used with or without neoprene socks. The foot pocket has a large heel pull tab for easy donning and doffing.



MARLIN

DIVING



WHITE

WHITE	Color BLACK	BLACK
	Talla/Size	
USA: 4/8	USA: 9/11.5	USA: 12/14
UE: 36/41	UE: 42/45	UE: 46/48
S/M	M/L	L/XL
	Referencia/SKU	
AR374037	AR332038	AR332039

ES
Aleta ajustable para buceo.
Aleta de dimensiones medias con una reactividad sorprendente y gran rendimiento propulsivo.
Es idónea tanto para el buzo principiante como el profesional, los instructores y buzos técnicos.

EN
Adjustable fin for scuba diving.
Regular dimension fin with amazing reactivity and great propulsive performance.
Ideal for the beginner diver as well as for professionals, instructors and technical divers.

SNAPPER

DIVING/SNORKELING



NO BOOTS REQUIRED.

Talla/Size	
USA: 5/9	USA: 10/13
UE: 37/42	UE: 43/47
S/M	L/XL
Referencia/SKU	
AR812302	AR812303



ES
La aleta ajustable Bonassi Snapper es una aleta para buceo recreativo y snorkeling que no necesita botas de neopreno para ser utilizada. Su calzante tiene una anatomía estudiada para ofrecer máxima comodidad y la pala en polipropileno de alta densidad es reactiva y nerviosa.
El aleteo es agradable y reactivo ofreciendo un buen desempeño aun cuando se trata de nado contra corriente. La aleta Snapper es extraordinaria desde el punto de vista práctico ya que se adapta prácticamente a todos los pies y que permite un calzado y descalzado rápido y fácil en cualquier situación. Perfecta para renta, el uso rudo, los tour operadores y los centros de buceo, con solo dos tallas es practica y agiliza la operación!

EN
The Bonassi Snapper adjustable fin is perfect for recreational diving and snorkling. You do not need to wear neoprene boots! The foot pocket has been designed to offer maximum comfort. The blade is constructed of high-density polypropylene and is very responsive. The kick is pleasant and the fin offers good performance even when swimming against the current. The Snapper is an extraordinarily practical fin since it adapts to all sizes and shapes of feet. It is the perfect rental or daily use fin and is designed with tour operators and diving centers in mind. The Snapper comes in 2 sizes for easy daily operations.



SHARK/WHALE

ADULT /JUNIOR



ORCA

SHARK COLORS ADULT



BLUE		YELLOW	
Tallas/Size			
USA: 5/9	USA: 10/13	USA: 5/9	USA: 10/13
UE: 37/42	UE: 43/47	UE: 37/42	UE: 43/47
S/M	ML/XL	S/M	ML/XL
Referencia/SKU			
AR032004 - AR032005		AR031002 - AR031003	

WHALE COLORS JUNIOR



BLUE		ORANGE	
Tallas/Size			
USA: 11/12.5	USA: 1/2.5	USA: 11/12.5	USA: 1/2.5
UE: 28/30	UE: 32/34	UE: 28/30	UE: 32/34
S/M	L/XL	S/M	L/XL
Referencia/SKU			
AR232004 - AR232005		AR232204 - AR031004	

ES
Aleta ajustable para snorkeling. Ideal para la renta y uso rudo. No necesita el uso de botas de neopreno. Disponibles refacciones y repuestos.

EN
Snorkeling adjustable fin. Ideal for rent and rough use. No neoprene boots needed. Replacement parts available.



YELLOW			
Tallas/Size			
USA: 3/4	USA: 5/6	USA: 7/8	USA: 9/10
UE: 36/37	UE: 38/39	UE: 40/41	UE: 42/43
Referencia/SKU			
AR351036	AR351038	AR351040	AR351042



BLACK				
Tallas/Size				
USA: 5/6	USA: 7/8	USA: 9/10	USA: 11/12	USA: 13/14
UE: 38/39	UE: 40/41	UE: 42/43	UE: 44/45	UE: 46/47
Referencia/SKU				
AR355038	AR355040	AR355042	AR355044	AR355046

ES
La aleta ORCA es de alto rendimiento. El buzo puede disfrutar de una patada excelente sin perder la comodidad de un calzante ergonómico. La pala de la aleta genera mucha potencia gracias a su tamaño y a sus dos rieles de hule que canalizan el agua durante la patada. La suma de esos detalles ayudan a maximizar el empuje y la maniobrabilidad y minimizan la tensión en las piernas.
Especificaciones:
Aleta de calzante cerrado
Flotabilidad: Neutral
Peso: 0,73 kg / 1,609 lb
Actividad: buceo, snorkeling avanzado.



BLUE					
Tallas/Size					
USA: 3/4	USA: 5/6	USA: 7/8	USA: 9/10	USA: 11/12	USA: 13/14
UE: 36/37	UE: 38/39	UE: 40/41	UE: 42/43	UE: 44/45	UE: 46/47
Referencia/SKU					
AR352036	AR352038	AR352040	AR352042	AR352044	AR352046

ES
The ORCA fin is high performance. The diver can enjoy an excellent kick without losing the comfort of an ergonomic foot pocket. The fin blade generates a lot of power due to its size and its two rubber rails that channel the water during the kick. These details help maximize thrust and maneuverability while minimizing stress on the legs.
Specs:
Closed foot pocket
Buoyancy: Neutral
Weight: 0.73 kg / 1.609 lb
Activity: diving, advanced snorkeling



CRAB



ES
Crab es una aleta indicada para snorkeling, freediving y buceo. Ha sido estudiada para resistir al uso mas rudo que puedan imaginar. Ideal para operaciones de renta, tour operadores, cooperativas pesqueras y centros de buceo, la aleta Crab tiene un calzante ergonomico y muy confortable también para un uso prolongado. La pala esta hecha en EVA.

Tallas/Size					
USA: 4/5	USA: 6/7	USA: 7.5/8	USA: 9/10	USA: 10.5/11.5	USA: 12/13
UE: 36/37	UE: 38/39	UE: 40/41	UE: 42/43	UE: 44/45	UE: 46/47
Referencia/SKU					
AR845036	AR845038	AR845040	AR845042	AR845044	AR845046

EN
Crab is a closed fin suitable for snorkeling, freediving and scuba diving. It is designed to resist to the strongest use. Ideal for rental, tour operators, fisherman and dive centers, the Crab fin comes with an ergonomic foot pocket that is extremely comfortable even during prolonged use. The blade is made in EVA material.



ANTHIAS



ES
La aleta Anthias es de calzante cerrado con un design clásico que nunca dejará de sorprender a los amantes de el snorkeling. Ligera, flexible y comoda. Que mas quieres para disfrutar del oceano?
Especificaciones:
Aléta de calzante cerrado
Flotabilidad: neutral
Peso: 0,5kg/ 1,10 lb
Actividad: Snorkeling

Tallas/Size					
USA: 1/2	USA: 3/4	USA: 5/6	USA: 7/8	USA: 9/10	USA: 11/12
UE: 34/35	UE: 36/37	UE: 38/39	UE: 40/41	UE: 42/43	UE: 44/45
Referencia/SKU					
AR362034	AR362036	AR362038	AR362040	AR362042	AR362044

ES
The ANTHIAS is a closed foot pocket fin with a classic design that will never cease to amaze snorkeling lovers. Light, flexible and comfortable. What else do you want to enjoy the ocean?
Specs:
Closed foot pocket fin
Buoyancy: neutral
Weight: 0.5kg / 1.10 lb
Activity: Snorkeling

COMBOS



PHOTOGRAPHY: @JUANPOPULARCINEMA

#UNDERWATERREVOLUTION

THE MOST SUITABLE EQUIPMENT SELECTION FOR ACTIVITIES SUCH AS SNORKELING AND SCUBA DIVING, WE HAVE CREATED COMBOS SETS FOR YOUR CONVENIENCE. MADE TO LAST.



/BONASSI.OFFICIAL

SET SNAPPER SNORKELING ADULT



ES

Mascara Juno

- Visor de silicona para adultos
- Correa fácil de ajustar
- Máscara de bajo perfil de 2 ventanas.

Tubo Barbados

- Parte superior semiseca diseñada para evitar que el agua entre al tubo respirador
- El conector de silicona hace que este snorkel sea ideal también para el buceo
- Boquilla de silicona para mayor comodidad.
- Válvula de purga unidireccional para facilitar la limpieza

Aleta Snapper

- Aleta ajustable ideal para buceo y snorkeling no necesita botas de neopreno.
- Aleta hecha con dos materiales proporciona una excelente potencia y eficiencia
- Calzante suave y cómodo
- Incluye bolsa para llevar y guardar el equipo.

EN

Juno Mask

- Silicon Adult mask
- Quick release buckles
- 2-window, low profile mask

Barbados Snorkel

- Semi dry top designed to prevent splashed surface water from entering the snorkel
- Silicon connector make this snorkel great for scuba diving
- Silicon mouthpiece for great comfort
- One-way purge valve for easy clearing

Snapper Fin

- Adjustable fin—great for diving and snorkeling. Does NOT need neoprene boots.
- Dual composite blades provide excellent power and energy saving efficiency
- Soft and comfortable foot pocket
- Includes travel bag to carry and store gear

NET BAG INCLUDED

Color

BLACK/TITANIUM

Tallas/Size

S/M - L/XL

Referencia/SKU

KT855002 - KT855003

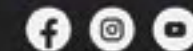

/BONASSI.OFFICIAL

SET JUNO

SNORKELING ADULT



NET BAG INCLUDED



NET BAG INCLUDED



ES

- Mascara Juno
- Visor de silicona para adultos
 - Correa fácil de ajustar
 - Máscara de bajo perfil de 2 ventanas.
- Tubo Jamaica
- Parte superior semiseca diseñada para evitar que el agua entre al tubo respirador
 - Conector en PVC
 - Boquilla de silicona para mayor comodidad.
 - Válvula de purga unidireccional para facilitar la limpieza
- Aleta Shark
- Aleta ajustable ideal snorkeling no necesita botas de neopreno.
 - Calzante suave y cómodo
 - Incluye bolsa para llevar y guardar el equipo.

Color	
BLACK/BLUE	BLACK/YELLOW
Tallas/Size	
S/M - L/XL	S/M - L/XL
Referencia/SKU	
KR112003 - KR112004	KR111003 - KR111004

EN

- Juno Mask
- Silicon Adult mask
 - Quick release buckles
 - 2-window, low profile mask
- Jamaica Snorkel
- Semi-dry top designed to prevent splashed surface water from entering the snorkel
 - PVC connector
 - Silicon mouthpiece for great comfort
 - One-way purge valve for easy clearing
- Shark Fin
- Adjustable fin doesn't need neoprene boots.
 - Soft and comfortable foot pocket
- Gear Bag
- Includes travel bag to carry and store gear.

ES

- Mascara Juventas
- Visor de silicon para niños
 - Correa fácil de ajustar
 - Visor de dos vidrios
- Tubo Haiti
- Parte superior semiseca diseñada para evitar que el agua entre al tubo respirador
 - Conector en PVC
 - Boquilla de silicona para mayor comodidad
 - Válvula de purga unidireccional para facilitar la limpieza
- Aleta Whale
- Aleta ajustable ideal snorkeling no necesita botas de neopreno
 - Calzante suave y cómodo
- Bolsa incluida
- Incluye bolsa para llevar y guardar el equipo.

Color	
BLACK/BLUE	BLACK/ORANGE
Tallas/Size	
S/M - L/XL	S/M - L/XL
Referencia/SKU	
KA215003 - KA215004	KA212203 - KA212204

EN

- Juppiter Mask
- Silicon junior mask
 - Quick release buckles
 - 2-window
- Tubo Haiti
- Semi dry top designed to prevent splashed surface water from entering the snorkel
 - PVC connector
 - Silicon mouthpiece for great comfort
 - One-way purge valve for easy clearing
- Whale Fin
- Adjustable fin doesn't need neoprene boots
 - Soft and comfortable foot pocket
- Gear Bag
- Includes travel bag to carry and store gear

SET JUVENTAS

SNORKELING

COMBO VENTURE PRO

ADULT



CLEAR/PINK



CLEAR/YELLOW



BLACK/BLUE



BLACK/BLACK



BLACK/YELLOW



BAG

Color

BLACK/BLUE CLEAR/PINK CLEAR/YELLOW BLACK/BLACK BLACK/YELLOW

Referencia/SKU

CS145020B CS140040B CS140010B CS145050B CS145010B



BLISTER

Color

BLACK/YELLOW BLACK/BLUE BLACK/BLACK CLEAR/YELLOW CLEAR/PINK

Referencia/SKU

CS145010 CS145020 CS145050 CS140010 CS140040

ES
Combina nuestra máscara de silicon negro con nuestro snorkel semiseco. La lente de vidrio templado de nuestra máscara está hecha de alta densidad y está diseñada para resistir la presión del buceo en agua profunda. Las correas y las hebillas de la máscara están hechas de plástico muy resistente. La parte superior del tubo es semiseca y evita la entrada de agua. El diámetro es amplio para facilitar la respiración. Boquilla ergonómica de silicona para mayor comodidad. La válvula de purga es ubicada en el punto más bajo para una rápida limpieza del tubo sin esfuerzo.

EN
Combine our black silicon mask with our semi-dry snorkel. The tempered glass lens on our mask is made of high-density plastic that's designed to withstand the pressure of deep water diving. The straps and buckles on the mask are made of high-durability plastic. The Semi-dry top snorkel prevents water entry into tube. Large bore flexible tube for easy breathing. Ergonomic silicon mouthpiece for added comfort. Purge valve at lowest point for effortless clearing.

COMBO NEMO

JUNIOR



CLEAR/YELLOW



BLACK/GREEN



CLEAR/PINK



BLACK/ORANGE

Color			
BLACK/GREEN	BLACK/ORANGE	CLEAR/YELLOW	CLEAR/PINK
Referencia/SKU			
CJ145030	CS145022	CJ140010	CJ140040

ES
El combo Nemo está hecho de suave silicon negro hipoalergénico con hebillas fáciles de ajustar. El silicon negro ayuda a prevenir el envejecimiento de la máscara incluso si se mantiene bajo el sol durante mucho tiempo. La lente de vidrio templado de nuestra máscara está hecha de alta densidad y está diseñada para resistir la presión del buceo en agua profunda. El tubo semiseco tiene un gancho para el ajuste rápido del tubo con la máscara. El esnórquel semiseco evita la entrada de agua en el tubo. Una pequeña boquilla de silicona ergonómica ayuda a los niños a prevenir irritaciones en la boca. La válvula de purga se encuentra en el punto más bajo y ayuda a limpiar el tubo.

EN
The Nemo combo is made from Soft Hypoallergenic black Silicone with easy adjustable buckles. The black silicon help to prevent the aging of the mask even if is left in the sun. The tempered glass lens on our mask is made of high-density that's designed to withstand the pressure of deep water diving. The Top Jr semi-dry snorkel has a Quick-Release Snorkel Keeper. The semi-dry top snorkel prevents water entry into tube. A small ergonomic silicon mouthpiece helps to prevent irritations to the mouths of children. The purge valve is located in the lowest point and it helps for clearing the tube.

SPEARFISHING



PHOTOGRAPHY: @JUANPOPULARCINEMA

WWW.BONASSI.IT

OUR SPEARFISHING GEAR IS DESIGNED AND MANUFACTURED IN ITALY.
OUR PASSION FOR SPEARFISHING IS IN OUR BLOOD AND WE DO TAKE THINGS SERIOUSLY TO
CREATE THE BEST GEAR FOR YOU TO ENJOY SPEARFISHING EVERYDAY AS WE DO.



BLUE ROLLER

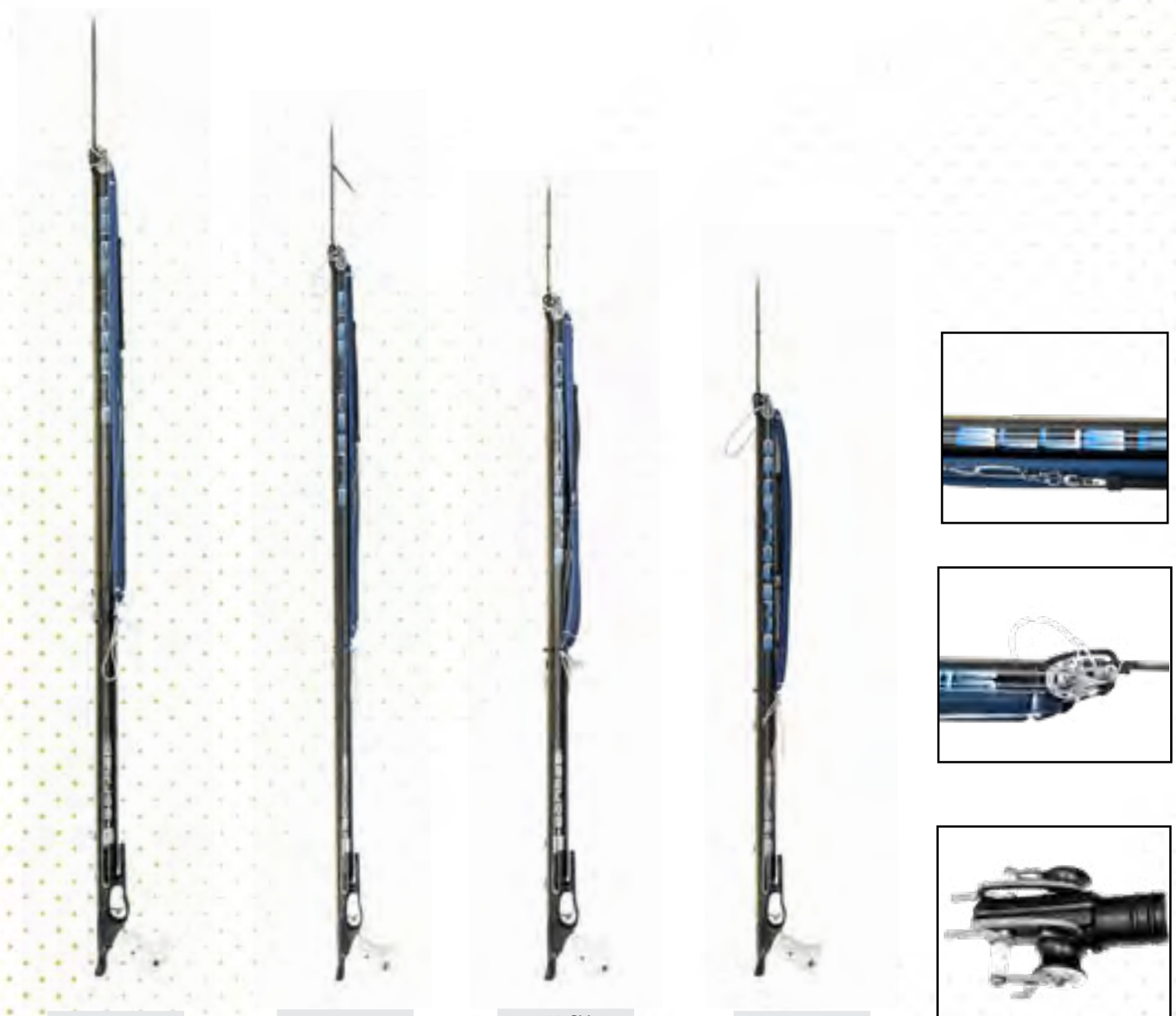

125 CM.
Referencia/SKU |
PF404125.

115 CM.
Referencia/SKU |
PF404115.

100 CM.
Referencia/SKU |
PF404100.

90 CM.
Referencia/SKU |
PF404090

ES
Cacha en Nylon y fibra de vidrio con mecanismo retrasado en acero inox 316. Pre carga del sistema roller ya armado de serie.
varilla de acero Sandvick de 7mm con dientes. El acero Sandvick es mas duro y ligero comparado con otros aceros templados.
tubo con diametro externo de 28mm, diametro interno 26mm. Guía para varilla integrado.
Cabezal abierto para dos ligas de 16mm.
Dos ligas de 16mm progresiva con factor de estiramiento de 3,2
Monofilamento de 1.8mm fluoro carbon y bungee con destorcidor
Empaque: Bolsa de tela.

EN
Nylon and fiberglass handle with 316 stainless steel mechanism.
7mm Sandvick steel shaft with shark fins.
Aluminum barrel with an external diameter of 28mm – and internal of 26mm integrated shaft guide.
Open head for two bands.
two progressive 16mm rubber bands.
1.8mm fluorocarbon monofilament and bungee with untwisting mechanism.



GOLIATH



125 CM.
Referencia/SKU | PF101125.

115 CM.
Referencia/SKU | PF101115.

100 CM.
Referencia/SKU | PF101100.

90 CM.
Referencia/SKU | PF101090.



SEA BASS



90 CM.
Referencia/SKU | PF303090.

75 CM.
Referencia/SKU | PF303075.

65 CM.
Referencia/SKU | PF303065.



ES
Cacha en Nylon y fibra de vidrio con mecanismo retrasado en acero inox 316. Pre carga del sistema roller ya armado de serie. varilla de acero Sandvick de 7mm con dientes. El acero Sandvick es mas duro y ligero comparado con otros aceros templados. tubo con diametro externo de 28mm, diametro interno 26mm. Guía para varilla integrado. Cabezal abierto para dos ligas de 16mm. Dos ligas de 16mm progresiva con factor de estiramiento de 3,2 Monofilamento de 1.8mm fluoro carbon y bungee con destorcidor Empaque: Bolsa de tela.

EN
Nylon and fiberglass handle with 316 stainless steel mechanism. 7mm Sandvick steel shaft with shark fins. Aluminum barrel with an external diameter of 28mm – and internal of 26mm integrated shaft guide. Open head for two bands. two progressive 16mm rubber bands. 1.8mm fluorocarbon monofilament and bungee with untwisting mechanism.

ES
Cacha en Nylon y fibra de vidrio con mecanismo retrasado en acero inox 316. Pre carga del sistema roller ya armado de serie. varilla de acero Sandvick de 6.5mm con pernos. El acero Sandvick es mas duro y ligero comparado con otros aceros templados. tubo con diametro externo de 28mm, diametro interno 26mm. Guía para varilla integrado. Cabezal abierto para dos ligas Una liga de 16mm progresiva con factor de estiramiento de 3,2 Monofilamento de 1.6mm fluoro carbon y bungee Empaque: Bolsa de tela.

EN
Nylon and fiberglass handle with 316 stainless steel mechanism. 6.5 mm Sandvick steel shaft with pins. Aluminum barrel with an external diameter of 28mm – and internal of 26mm integrated shaft guide. Open head for two bands. 16mm progressive rubber bands. 1.6mm fluorocarbon monofilament and bungee.



#UNDERWATERREVOLUTION

PHOTOGRAPHY: @ELESERENAFUSATO_UWPHOTO

KNIVES

BE READY, WHENEVER YOU NEED WE ARE READY TOO.
OUR KNIVES ARE MADE IN ITALY WITH THE HIGHEST STANDARDS
SO YOU CAN BE SAFE ON YOUR DIVES.



BLACK

Color

Black

Referencia/SKU

ZP170009

Peso/Weight: 154 g - 5.43 oz
Largo de cuchillo/ knife length: 24 cm - 9.44"
Largo de la hoja/Blade length: 12 cm - 4.72"
cuchillo con tapa de teflón/knife black coating :
IDROGLIDER GOLD® Black

BLACK/YELLOW

Color

Black/Yellow

Referencia/SKU

ZP170005

ES

El Cuchillo Bonassi Gladio es un excelente cuchillo para aquellos lo usan como una herramienta bajo el agua.

El cuchillo está hecho de acero inoxidable 4116 y está disponible también en una versión recubierta de IDROGLIDER GOLD negro que aumenta la resistencia a la corrosión. La hoja tiene un lado plano y un lado con sierra que también incluye un corta líneas. El mango tiene un diseño ergonómico y esta hecho de un termoplástico suavizado (PP con TPE) para asegurar un perfecto agarre. La hoja mide 12 cm - 4.72" y la medida total del cuchillo es de 24 cm - 9.44". Con el cuchillo viene incluida una funda rígida con mecanismo de seguridad para uso de una sola mano y con dos cinchos que permiten fijarlo al muslo.

EN

The Bonassi Gladio Knife is an excellent dive knife for those who use their knife as a tool while underwater.

The Knife is made from 4116 stainless steel and also available with a IDROGLIDER GOLD® Black coated blade treatment for a better corrosion resistance. The blade has one side with a straight edge; the other side is partially serrated and also comes equipped with a line cutter. The handle has an anatomical shape and is composed of "soft grip" (PP with TPE) material for a secure grip. The blade length is 12 cm - 4.72" with an overall knife length of 24 cm - 9.44". Knife comes with a durable impact resistant sheath with locking mechanism for one-hand release. Included are 2 adjustable leg straps.



VENDETTA



INOX
Referencia/SKU

ZP170006



STRAP INCLUDED

Peso/Weight: 85 g - 2.99 oz
Largo de cuchillo/knife length: 18 cm - 7.08"
Largo de la hoja/Blade length: 9 cm - 2.75"
cuchillo con tapa de teflón/knife black coating : PTFE Black



TEFLON
Referencia/SKU

ZP170007



CORSARIO



TEFLON YELLOW
Referencia/SKU

ZP170004



TEFLON BLACK
Referencia/SKU

ZP170002

Peso/Weight: 115 g - 4.05 oz
Largo de cuchillo/Knife length: 23 cm - 9.05"
Largo de la hoja/Blade length: 11,5 cm - 4.52"
Knife black coating : IDROGLIDER GOLD® Black

ES

El Cuchillo Bonassi Vendetta es perfecto para aquellos que les gusta portar el cuchillo en el cinturón de plomos, pero por su tamaño puede ser fácilmente fijado al BCD o al muslo. La larga punta estilo stiletto es perfecta para neutralizar los grandes pescados.

El cuchillo está hecho de acero inoxidable 4116 y está disponible en una versión recubierta de IDROGLIDER GOLD negro que aumenta la resistencia a la corrosión. La hoja tiene un lado plano, un lado con sierra. El mango tiene un diseño ergonómico y esta hecho de un material termoplástico suavizado (PP con TPE) para asegurar un perfecto agarre.

La hoja mide 11,5 cm - 4.52" y la medida total del cuchillo es de 23 cm - 9.05". En el empaque esta incluida una funda rígida con mecanismo de enganche a presión y con dos cinchos que permiten fijarlo al muslo.

EN

The Bonassi Vendetta Knife is perfect for who love to keep the knife on the weight belt, but for its size, can be easily fastened to a BCD or to the leg. The long stiletto blade is perfect to easily and humanely impale a big speared fish. The Knife is made from 4116 stainless steel with a IDROGLIDER GOLD® Black coating blade treatment for a better corrosion resistance. The blade has one side with a straight edge and the other side is partially serrated. The handle has an anatomical shape and is composed of a "soft grip" (PP with TPE) material for a secure grip. The blade length is 11,5 cm - 4.52" with an overall knife length of 23 cm - 9.05". Knife comes with a durable impact resistant sheath with locking mechanism for one-hand release and also includes 2 adjustable leg straps.

ES

El cuchillo Bonassi Corsario es perfecto para el pescador submarino.

La punta tipo stiletto es perfecta para neutralizar el pescado. El cuchillo está hecho de acero inoxidable 4116 y contamos también con una versión recubierta de teflón que aumenta la resistencia a la corrosión. La hoja del cuchillo tiene un lado plano y un lado con sierra. Este cuchillo esta hecho todo de una sola pieza de acero y el mango tiene un diseño ergonómico. La hoja mide 2.75" (7cm) y la medida total del cuchillo es de 7.08" (18cm). Incluido con el cuchillo viene una funda y un cincho de velcro para poder sujetarlo al brazo.

EN

The Bonassi Corsario Knife is the perfect knife for the spear fisherman, but because of its size, it can be easily fastened to a BCD. The stiletto style tip is perfect to easily and humanely impale the speared fish. The Knife is made from 4116 stainless steel and also available with a TEFLON black coating blade treatment for better corrosion resistance. One edge of the blade is straight and straight edge and the other side is partially serrated. This is one-piece knife and the handle is ergonomically designed for better grip. The blade length is 2.75" (7cm) with an overall knife length of 7.08" (18cm). Knife comes complete with a durable knife sheath with a knife holder strap for fastening it to the arm.

SPEARFISHING ACCESORIES



PHOTOGRAPHY: @JAMJAVIERSANROMAN

OUR FISHING GEAR IS DESIGNED AND MADE IN ITALY, AND WE PROVIDE EVERYTHING NEEDED FOR SPEARFISHING, ACCESSORIES AND SPARE PARTS FOR YOU TO DON'T STOP EXPLORING AND GOING DEEPER.



SHAFT SRK WITH SHARK FINS



- ø 7mm/110cm Referencia/SKU: PV700110.
- ø 7mm/125cm Referencia/SKU: PV700125.
- ø 7mm/130cm Referencia/SKU: PV700130.
- ø 7mm/135cm Referencia/SKU: PV700135.
- ø 7mm/140cm Referencia/SKU: PV700140.
- ø 7mm/150cm Referencia/SKU: PV700150.
- ø 7mm/160cm Referencia/SKU: PV700160.

- ø 7.5mm/130cm Referencia/SKU: PV750130.
- ø 7.5mm/140cm Referencia/SKU: PV750140.
- ø 7.5mm/150cm Referencia/SKU: PV750150.
- ø 7.5mm/160cm Referencia/SKU: PV750160.
- ø 7.5mm/170cm Referencia/SKU: PV750170.

ES

Las varilla Bonassi SRK están hechas de acero Sandvik con tratamiento térmico de 48/50 HRC que las hace muy tenaces incluso cuando golpean las rocas más duras. La peculiaridad de esta serie está representada por la presencia de dientes de enganche para el archo ogival a forma de aleta de tiburón que se sueldan con láser todo al rededor por lo que se evita la presencia de puntos críticos estructurales.

Todas las varillas están equipadas con 3 dientes, 2 de los cuales se agrupan en una posición hacia atrás, mientras que el ultimo está más adelantado y su objetivo es ayudar a cargar el arpon. Todos los dientes tienen el agujero para el paso del monofilamento (diámetro maximo 2.1mm) con el fin de ofrecer una gama más amplia de ajustes para el pescador. Todos los dientes están pulidos y terminados a mano para no tener bordes abrasivos que puedan dañar el monofilamento.

EN

The Bonassi SRK shaft are made of Sandvik steel with heat treatment 48/50 HRC that makes them very tenacious even when they hit the hardest rocks. The peculiarity of this series is represented by the presence of shark-fin pins that are laser-welded in a non-through housing which avoids the presence of structural critical points.

All the shafts are equipped with 3 shark-fin pins, 2 of which are grouped together in a backward position while the last one is more distant and it is aimed to help loading the speargun only. All the fins have the hole for the passage of the monofilament -max diameter 2.1mm- in order to offer a wider range of possibilities to the user. All are polished and finished by hand so as not to have abrasive edges that could damage the monofilament.



SHAFT TRK

WITH PINS

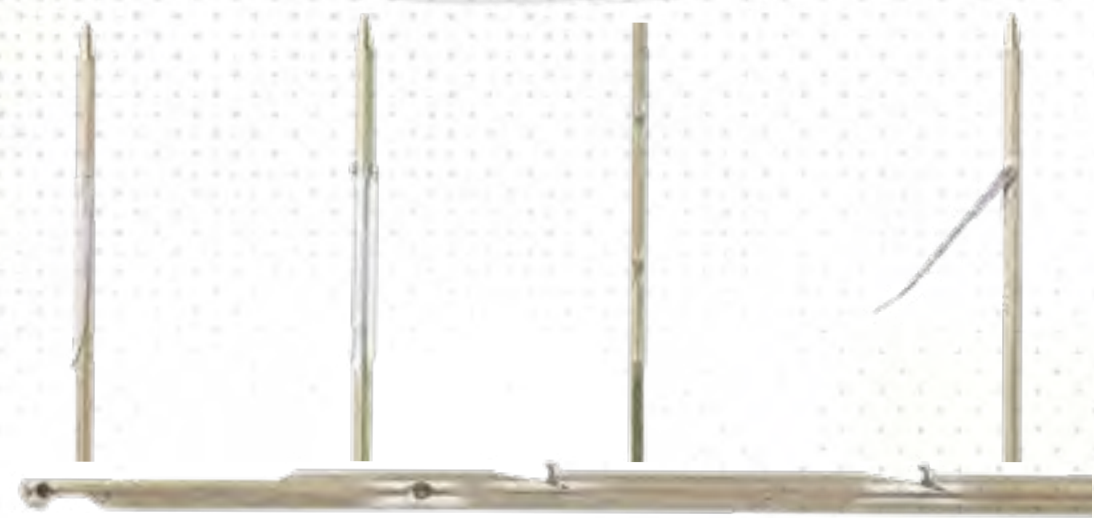

Ø 6.5mm/90cm
Referencia/SKU |
PV165090.

Ø 6.5mm/110cm
Referencia/SKU |
PV1650110.

Ø 6.5mm/115cm
Referencia/SKU |
PV165115.

Ø 6.5mm/125cm
Referencia/SKU |
PV165125.

Ø 6.5mm/135cm
Referencia/SKU |
PV165135.

ES
Las varilla Bonassi TRK están hechas de acero Sandvik con tratamiento térmico de 48/50 HRC que las hace muy tenaces incluso cuando golpean las rocas más duras.
Todas las varillas están equipadas con 2 dientes los cuales se agrupan en una posición hacia atrás.
En la parte trasera, en el cuerpo de la varilla se encuentra el juego en donde pasar el monofilamento. Diámetro máximo 2.1mm

ES
The Bonassi TRK Shaft are made of Sandvik steel with heat treatment 48/50 HRC that makes them very tenacious even when they hit the hardest rocks.
All the shafts are equipped with 2 pins which are grouped together in a backward position.
On the backward position, into the shaft body, there is one hole for the passage of the monofilament -max diameter 2.1mm



SHAFT CLASSIC



Referencia/SKU
PV265090 PV265100
Talla/Size
Ø 6.5mm/90cm Ø 6.5mm/100cm

Referencia/SKU
PV265110 PV265115
Talla/Size
Ø 6.5mm/110cm Ø 6.5mm/115cm

Referencia/SKU
PV265125 PV265130
Talla/Size
Ø 6.5mm/125cm Ø 6.5mm/130cm

Referencia/SKU
PV265140 PV265150
Talla/Size
Ø 6.5mm/140cm Ø 6.5mm/150cm

ES
Varilla de 6.5mm en acero Sandvick con cortes para usarse especialmente con arcos ojivales de metal.

EN
6.5mm shaft in Sandvick steel with cuts to be used especially with metal wishbone.

ROLLER MUZZLE



Referencia/SKU
PA301001

TWO RUBBER OPEN MUZZLE



Referencia/SKU
PA301010

UNIVERSAL REEL



Referencia/SKU
876

TOP REEL BLACK 41 MT/135FT



Referencia/SKU
PA201001



RUBBER BANDS

STANDARD ID RUBBER
2.5mm ø 14mm (15MT/49FT)



Color
BLACK
Referencia/SKU
PL502514X15

SMALL ID RUBBER
1.5mm ø 16mm (15MT/49FT)



Referencia/SKU
PL211516X15



RUBBER BANDS

STANDARD ID RUBBER
2.5mm ø 16mm (15MT/49FT)



	Color		
Black	Sky Blue	Orange	Green
Referencia/SKU for box			
PL502516X15	PL202516X15	PL222516X15	PL312516X15



ES
Goma suave y reactiva fabricada en Italia con látex 100% natural de Malasia. Fácil de cargar y con un rendimiento de disparo asombroso. Su factor de estiramiento máximo es de 7 veces, pero se recomienda usarlo con un factor de estiramiento entre 3 y 3.5 veces. Gracias a sus propiedades específicas de memoria, después de períodos prolongados de estrés, las pruebas de rendimiento han demostrado un aumento general del rendimiento de más del 10% en comparación a una goma tradicional. Particularmente evidente es el aumento obtenido en términos de la tasa de contracción del caucho, resultado de la explosividad obtenida sin afectar la fluidez tradicional de la goma. Tratamiento de silicona. La silicona penetra la superficie y se consolida formando una barrera protectora contra los rayos UV y agentes externos. Para aumentar la eficacia del producto se recomienda proteger periódicamente la goma tratándola con silicona líquida.

EN
Soft and reactive speargun rubber made in Italy with 100% Malaysian natural latex. Easy to load and with incredible shooting performance. It has a maximum stretch factor of 7, but is recommended to use with a stretch factor between 3 to 3.5 times. Thanks to its specific memory properties, after prolonged periods of stress, performance tests have shown a general increase in performance of over 10% compared to a traditional compound. Particularly evident is the increase obtained in terms of the contraction rate of the rubber, the result of the explosiveness obtained without affecting the traditional fluidity of compounds. Silicone treatment. The silicone penetrates and consolidates on the surface forming a protective barrier against UV rays and external agents. To increase the efficiency of the product it is recommended to protect the rubber by treating it with liquid silicone periodically.

PUFFER ROUND BUOY

Referencia/SKU
BA100101

ES
Boya redonda doble camera en Nylon 210 denares y tres anillos de acero con especiales refuerzos textiles para poder amarrar objetos y accesorios
Camara de aire interna en PVC
Resistente a las abrasiones ya que la doble capa protege la camera interna.
Bandera de plástico con enganche a bayoneta
Características técnicas:
-Camara de aire interna en PVC
-Capa externa en Naylon 210 denares y una capa de resina protectora
-3 anillos de acero inox de 25mm
-Medidas 32cm x 23cm



EN
Puffer Round Buoy
Round double layer Nylon 201 deniers buoy. Features three stainless steel D-Rings with reinforcements to be able to tie objects and accessories
Internal PVC air bladder
Resistant to abrasions since the double layer protects the inner bladder
Plastic flag with bayonet included
Technical features:
-Internal PVC air bladder
-External Nylon layer 210 deniers
-3 / 25mm stainless steel rings
-Size: diameter 12.5 in

PVC TORPEDO BUOY

28X88CM

Referencia/SKU
BA110204

ES
Boya torpedo para la pesca submarina en PVC. Viene con linea flotante de 25mt de largo y mosquetón de plástico. Bandera de plástico con enganche a bayoneta 4 Anillos de plásticos vulcanizados por amarrar accesorios a la boya. Medidas: 88cm X 28cm

EN
PVC Torpedo Buoy
Spearfishing PVC Torpedo buoy. Includes a 82ft floating line and plastic carabiner.
Plastic flag with bayonet attachment included
4 vulcanized plastic connections for attaching accessories to the buoy
Size: 34.5in X 11in



PVC ROUND BUOY

Referencia/SKU
BA100203

ES
Boya redonda en PVC con bandera integrada inflable.
Viene con linea flotante de 25mt de largo y mosquetón plástico.
Medidas: diámetro 38cm / bandera de 15cm.



EN
Round PVC buoy with integrated inflatable flag.
Includes a 82ft floating line and a plastic carabiner.
Size: diameter 15in.

Referencia/SKU
BA110102

ES
Boya doble camera para la pesca submarina con anillos de aceros inox y costuras reforzadas para resistir a una fuerza de arrastre elevada. Perfecta para la pesca submarina con linea flotante. Resistente a las abrasiones ya que la doble capa protege la camera interna.
Características técnicas: -Camara de aire interna en pvc -Capa externa en Naylon 210 denares y una capa de resina protectora -4 anillos de acero inox de 40mm -Extremidades reforzadas para aguantar un elevado cargo de arrastre -Medidas: 80cm x 20cm

EN
Torpedo double layer buoy for spearfishing with four stainless steel D-Rings and reinforced seams to resist high drag.
Perfect for spearfishing with a floating line. Abrasion resistant as the double layer protects the inner bladder.
Technical features:
-PVC Internal air bladder / -Nylon 201 denier external layer
-4 x 40mm stainless steel D-rings
-Reinforced seams to withstand high drag
-Sizes: 32in x 7.8in / Size: diameter 15in.

TORPEDO TRAVELLY PRO



DYNEEMA PU COTING



1.5mm Black Referencia/SKU: LD500015

1.5mm Yellow Referencia/SKU: LD100015

2mm Black Referencia/SKU: LD500020

1.8mm Black Referencia/SKU: LD500018

1.8mm Yellow Referencia/SKU: LD100018

ES
Anima de Dyneema envuelta en Dyneema mas un capa protectora de poliuretano.

El dyneema, también conocido como Cuben Fiber, es un material compuesto no tejido de alto rendimiento que se utiliza en aplicaciones de alta resistencia. Está construido a partir de una fina lámina de poliestireno de peso molecular ultra alto. El revestimiento externo protector de poliuretano le confiere una excelente propiedad hidrodinámica, no le quita mucha potencia a tu disparo y aumenta mucho la resistencia.

Ø1.5mm - 245kg / 540lb x 50mt / 165ft
Ø1.8mm - 310kg / 685lb x 50mt / 165ft
Ø2.0mm - 354kg / 780lb x 50mt / 165ft

EN
Dyneema core, wrapped with Dyneema and a polyurethane coating.

Dyneema, also known as Cuben Fiber, is a high-performance non-woven composite material used in high-strength applications. It is constructed from a thin sheet of ultra-high-molecular-weight polyethylene. The external protective polyurethane coating gives it excellent hydrodynamic properties without significantly decreasing power from your shot. It also increases the resistance.

Ø1.5mm - 245kg / 540lb x 50mt / 165ft
Ø1.8mm - 310kg / 685lb x 50mt / 165ft
Ø2.0mm - 354kg / 780lb x 50mt / 165ft

POLYESTER LINE 50 METERS



1mm Referencia/SKU: LP000015

DYNEEMA LINE 50 METERS



1.3mm Referencia/SKU: LD000013

1.5mm Referencia/SKU: LD000015

1.8mm Referencia/SKU: LD000018

2.5mm Referencia/SKU: LD000025

2.0mm Referencia/SKU: LP000020

NYLON LINE

1.8 mm+ 2 RIVETS (7 METERS)

Referencia/SKU
PA101207



PACK 10 PCS RIVET 1.8mm



Referencia/SKU
PA101210

ARTICULATE WISHBONE INOX



Referencia/SKU
AB150

VELCRO KNIFE STRAP HOLDER



Referencia/SKU
ZP180001

RUBBER BELT WITH STAINLESS STEEL BUCKLE



Referencia/SKU
1120

MARSEILLESA RUBBER BELT WITH BUCKLE



Referencia/SKU
1122

OVAL FISH HOLDER IN STAINLESS STEEL ø 6,00mm (195x408mm)



Referencia/SKU
AB800

RING FISH HOLDER IN STAINLESS STEEL ø 3,5mm



Referencia/SKU
AB801

BELT WITH INOX BUCKLE



NYLON WEIGHT BELT WITH STAINLESS STEEL BUCKLE
Referencia/SKU
CININOX

BELT WITH PLASTIC BUCKLE



NYLON WEIGHT BELT WITH PLASTIC BUCKLE
Referencia/SKU
CINPLAS

VIDEO ADAPTER



Referencia/SKU
PA201002

BUNGEE



Referencia/SKU
PA101205

PLASTIC BELT BUCKLE



Referencia/SKU
001128

STAINLESS STEEL BELT BUCKLE



Referencia/SKU
AB140

SWIVEL 2.6X10CM - 100KG



Referencia/SKU
SA-AP070/26

HANDLE



Referencia/SKU
PA301006

#UNDERWATERREVOLUTION

2023



PHOTOGRAPHY: @JUANPOPULARCINEMA

DIVING accessories

THE IMPORTANCE OF HAVING RELIABLE GEAR UNDERWATER IS ESSENTIAL.
OUR VARIETY OF DIVING ACCESSORIES IS GREAT FOR YOU TO PICK ALL YOU NEED FOR YOUR
UNDERWATER ADVENTURES.

SPOOLS

NO LINE

2023



ALUMINIUM SPOOL RED
10MT - 33 FT
Referencia/SKU
AB210

ALUMINIUM SPOOL GREEN
15MT - 50 FT
Referencia/SKU
AB215

ALUMINIUM SPOOL ORANGE
30MT - 100 FT
Referencia/SKU
AB230

ALUMINIUM SPOOL BLUE
45MT - 150 FT
Referencia/SKU
AB245

SPOOL DERLIN 30MT - 100FT NO LINE



Referencia/SKU
AB430

SPOOL WITH SNAP AND LINE



SPOOL 15MT - 50FT
Referencia/SKU
AB515

SPOOL 30MT - 100FT
Referencia/SKU
AB530

SPOOL 45MT - 150FT
Referencia/SKU
AB545

LINE + DOUBLE EYE



15MT
Referencia/SKU
AB615

45MT
Referencia/SKU
AB645

30MT
Referencia/SKU
AB630

SHAKER



Color
Steel
Referencia/SKU
001465

NYLON BELT ROLL 50 METERS - 165 FT



Referencia/SKU
CINTROL

SNAP SWIVEL



75MM - SMALL
Referencia/SKU
AB110

SWIVEL 108MM - LARGE
Referencia/SKU
AB115

DOUBLE EYE SNAP



100MM -LARGE
Referencia/SKU
AB125

90MM - SMALL
Referencia/SKU
AB120

PLASTIC HANGER FOR BCD



Referencia/SKU
AC550BK

PLASTIC HANGER FOR WETSUIT



Referencia/SKU
AC540BK

D RINGS STAINLESS STEEL



SMALL, 50X30MM

Referencia/SKU: AB130

45* 50X40MM

Referencia/SKU: AB139

LARGE, 50X40MM

Referencia/SKU: AB135

STAINLESS STEEL WEIGHT KEEPER



Referencia/SKU
WK-SS

Referencia/SKU
BN901008



MESH BAG FOR DIVING EQUIPMENT



SMB PRO WITH PRESSURE VALVE 110X15cm / 3.6ftx6in

SMB REC PVC 130x16cm / 4.5ftx6in

Referencia/SKU
BA140508



Referencia/SKU
BA120305



HIGH PRESSURE HOSE

BLACK - 80CM
Referencia/SKU: HP80



BLACK - 25CM
Referencia/SKU: HP25

MOUTH PIECES FOR REGULATOR (SHORT BITE)

PACK 10 PCS
Referencia/SKU: SRSB001



LOW PRESSURE REGULATOR HOSE

LOW PRESSURE BCD INFLATOR HOSE

YELLOW - 100CM
Referencia/SKU: BP100J



BLACK - 73CM
Referencia/SKU: BP73

BLACK - 100CM
Referencia/SKU: BPGAV



DIN - INT ADAPTER



Referencia/SKU: RA1210101

INT - DIN CONVERSION KIT



Referencia/SKU: RK1010101

DUST CUP INT AND DIN



Referencia/SKU: INT: RA121011 / DIN: RA12101D

MASK REPLACEMENTS



PACK OF 10 PCS -MASK BUCKLES (JUNO, JUPITER)

Referencia/SKU

RV200

PACK OF 10 PCS -MASK BUCKLES (APOLLON, ATHENA, ARTEMIS)

Referencia/SKU

RV202

PACK OF 10 PCS -MASK STRAP (JUNO, JUPITER)

Referencia/SKU

RV203P

PACK OF 10 PCS -MASK STRAP (JUNO, JUPITER)

Referencia/SKU

RV205P



PACK OF 10 PCS -MASK BUCKLES (HERCULES)

Referencia/SKU

RV201

PACK OF 10 PCS -MASK BUCKLES (JUVENTAS)

Referencia/SKU

RV206

PACK OF 10 PCS -MASK STRAP (JUNO, JUPITER)

Referencia/SKU

RV204P

SNORKEL REPLACEMENTS



PACK OF 10 PCS - SNORKEL CLIP - CIRCULAR- DELUX (BARBADOS)

Referencia/SKU

RS300

PACK OF 10 PCS - SNORKEL CLIP - OVAL (ANTIGUA)

Referencia/SKU

RS308

PACK OF 10 PCS - SNORKEL CLIP -CIRCULAR (JAMAICA, BAHAMAS)

Referencia/SKU

RS301

PACK OF 10 PCS - SNORKEL CLIP - CIRCULAR -ECONOMIC

Referencia/SKU

RS303

PACK OF 10 PCS - SILICON MOUTHPIECE (HAITI)

Referencia/SKU

RS307P

PACK OF 10 PCS - PVC MOUTHPIECE (MARTINICA)

Referencia/SKU

RS304P

PACK OF 10 PCS - SILICON MOUTHPIECE

Referencia/SKU

RS305P

PACK OF 10 PCS - SILICON MOUTHPIECE

Referencia/SKU

RS309P

PACK OF 10 PCS - SILICON MOUTHPIECE (DOMINICA)

Referencia/SKU

RS311P

PACK OF 10 PCS - SILICON MOUTHPIECE (BAHAMAS)

Referencia/SKU

RS310P

PACK OF 10 PCS - MEMBRANE

Referencia/SKU

RS302P

PACK OF 10 PCS - SILICON CLIP "8"

Referencia/SKU

RS306P

FINS REPLACEMENTS



PACK OF 10 PCS - FINS STRAP + BUCKLES (SNAPPER)

Referencia/SKU

RA412P

PACK OF 10 PCS - FINS STRAP + BUCKLES (SHARK)

Referencia/SKU

RA400P

ONE FINS STRAP + TWO BUCKLES (MARLIN)

Referencia/SKU

RA413

BCD'S ACCESSORIES AND SPARE PARTS

BONASSI KOALA INFLATOR TECH

Referencia/SKU
BOD072

KOALA, DOC AND KANGU' LOWER FAST EXHAUST VALVE

Referencia/SKU
CH - A009 - 1.2

KOALA, DOC AND KANGU'HIGHER FAST EXHAUST VALVE

Referencia/SKU
CH - A009 - 1.4

KOALA, DOC AND KANGU' ELBOW FOR WINDPIPE

Referencia/SKU
CH - A041

BCD WEIGHT POCKET

Referencia/SKU
CH - A100

KOALA, DOC AND KANGU' INTERNAL THREAD FOR exhaust valve

Referencia/SKU
CH - F016

KOALA AND KANGU' WINDPIPE

Referencia/SKU
CH - F136

KANGU BCD INFLATOR PARTS

INFLATOR BUTTON

Referencia/SKU
CH - F081

O-RING 2037 INFLATOR BUTTON

Referencia/SKU
CH - E069

DISINFLATOR BUTTON

Referencia/SKU
CH - F109

O-RING 117 DISINFLATOR BUTTON

Referencia/SKU
CH - E024

KANGU' INFLATOR

Referencia/SKU
CH - D028

BCD'S MAINTENANCE KIT

KOALA AND DOC INFLATOR KIT

Referencia/SKU
CH - C232

PIVOT VALVE

Referencia/SKU
CH - E032

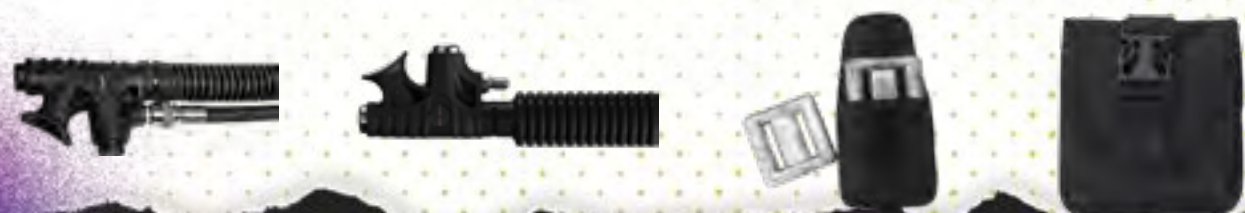

TANK ACCESSORIES AND SPARE PARTS

INSERT 200 BAR DIN TO YOKE

Referencia/SKU
RA30D



TANK ACCESSORIES AND SPARE PARTS



PACK 10 PCS - O-RING FOR LOW HOSE

Referencia/SKU
OR1010103



PACK 10 PCS - O-RING FOR HIGH HOSE

Referencia/SKU
OR1010101

REGULATORS MAINTENANCE KIT



EN

Referencia/SKU

KIT EOLO FIRST STAGE INT

RK101011

KIT EOLO FIRST STAGE DIN

RK10101D

KIT 10 PCS. EOLO SEAT FIRST STAGE

RR1010106X10

KIT 10 PCS. CONIC FILTER + CLIP EOLO FIRST STAGE

RR1010105X10

KIT EOLO SECOND STAGE

RK1010201

KIT 10 PCS. POPPET SEAT EOLO SECOND STAGE

RR1210201X10

KIT ZEPHYR FIRST STAGE INT

RK201011

KIT ZEPHYR FIRST STAGE DIN

RK20101D

KIT ZEPHYR SECOND STAGE

RK2010201

MAINTENANCE TOOLS



PHOTOGRAPHY: @JUANPOPULARCINEMA

THE BEST WAY TO GET YOUR GEAR TO LAST IS TO KEEP IT'S MAINTENANCE CONSTANT.
WE HAVE ALL YOU NEED TO KEEP YPUR EQUIPMENT IN THE BEST SHAPE.



ORING PICK SET

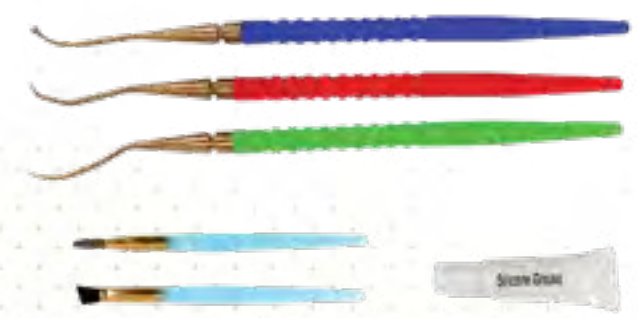

Referencia/SKU
RH1211202

SPANNER WRENCH - FLAT SURFACE



Referencia/SKU
TL135

YOKE NUT REMOVING SOCKET AND WRENCH



Referencia/SKU
RH1010102

REGULATOR SUPPORT HANDLE WRENCH



Referencia/SKU
RH1210101

Apriete y desapriete tuerca de fijación del estribo. Acero inox con perfiles redondeados. Gran brazo de palanca.

SPANNER WRENCH - ROUND SURFACE



Referencia/SKU for EOLO RH1010104 Referencia/SKU for ZEPHYR RH2010101

SILICON GREASE 225 gr



Referencia/SKU
GRASIL

Llave inglesa superficie redonda para desmontaje primera etapa regulador.

O-RING TOOLS

BCD'S MAINTENANCE TOOLS

REMOVING TOOL FIRST SEAT



Referencia/SKU
RH1010103

INSERT TOOL FOR SECOND POPPET



Referencia/SKU
RH1210203



Referencia/SKU
CH - C223

SECOND STAGE DIAPHRAGM COVER TOOL



Referencia/SKU
RH1210204

INTERMEDIATE 1ST STAGE PRESSURE GAUGE



Referencia/SKU
RH1210102

KOALA AND DOC BCD (INFLATOR TOOL)



Referencia/SKU
CH - G113

SCHRADER VALVE TOOL



Referencia/SKU
CH - H001

TOOLS KITS FOR REGULATOR (1ST AND 2ND STAGE)



Referencia/SKU
RK12112



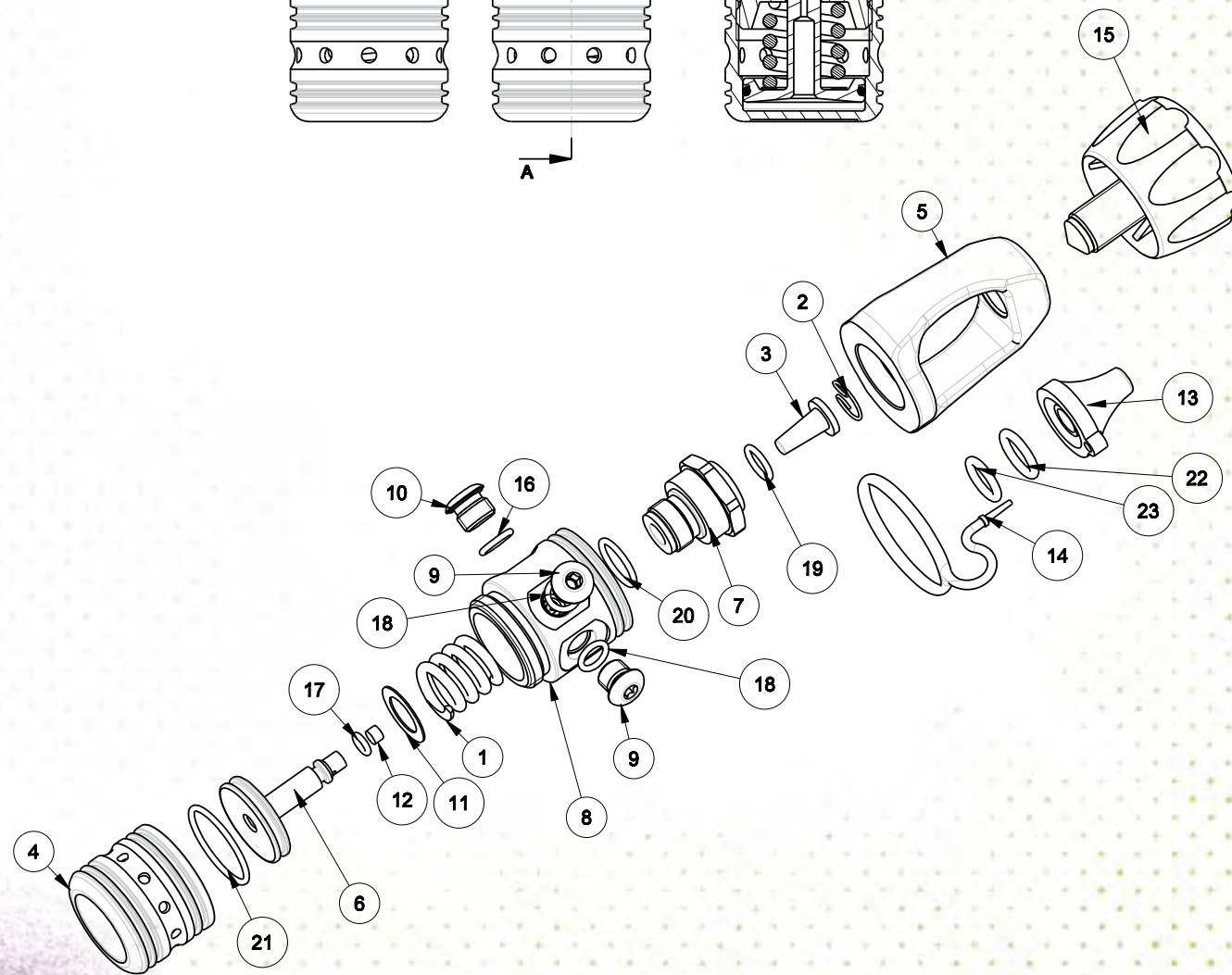
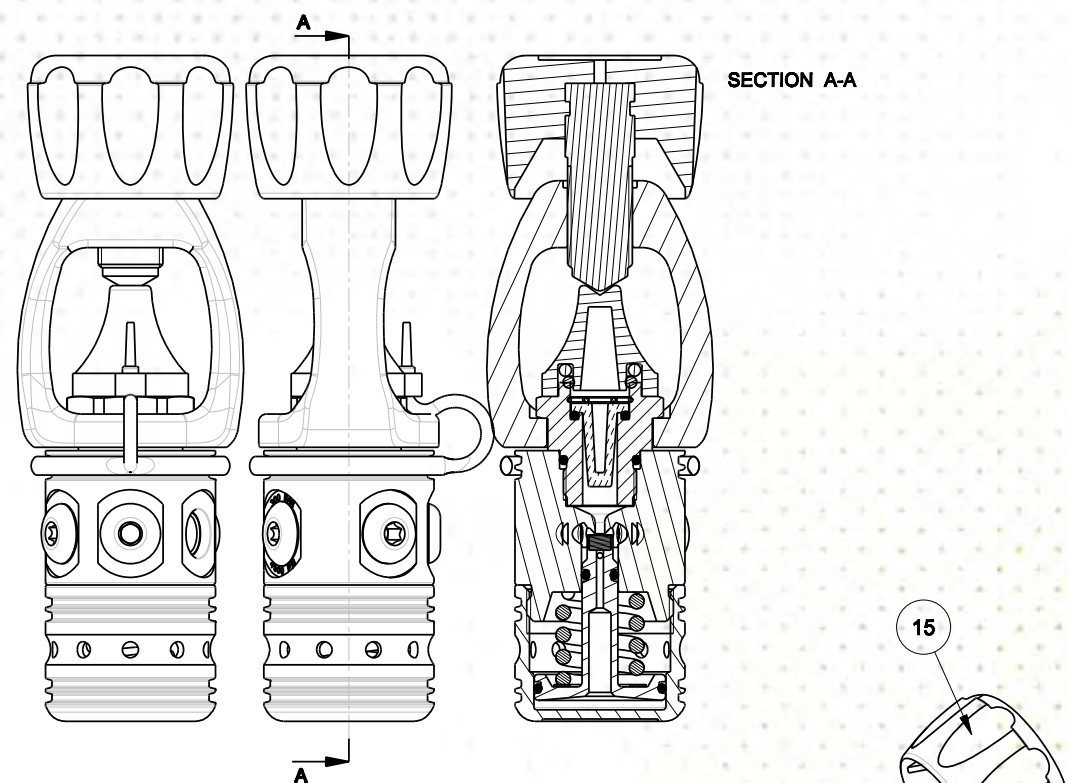

Numero	ES	EN	Referencia
1	RESORTE PISTON NO BALANCEADO	UNBALANCED PISTON SPRING	RR1010101
2	CLIP FILTRO INOX	SNAP RING	RR1010102
3	FILTRO CONICO EOLO INT	INT CONE-SHAPED FILTER	RR1010105
4	TAPA CON ROSCA DE METAL	UNBALANCED PISTON CAP	RR1010103
5	YOKE	YOKE	RR1010104
6	PISTON NO BALANCEADO	UNBALANCED PISTON	RR1010107
7	ROSCA PARA YOKE	YOKE NUT	RR1010108
8	CUERPO PRIMERA ETAPA PISTON NO BALANCEADO	UNBALANCED PISTON FIRST STAGE BODY	RR1010109
9	TAPON BP 3/8	LP PLUG 3/8	RR1010110
10	TAPON HP 7/16	HP PLUG 7/16	RR1010111
11	RONDANA DE TEFLON	SETTING WASHER	RR1010112
12	ASIENTO PRIMERA ETAPA EOLO	UNBALANCED PISTON SEAT	RR1010106
13	TAPON ANTIPOLVO	DUST CAP	RA121011
14	ANILLO DE ULE P/TAPON ANTI POLVO	RETAINER CAP RING	RR1010113
15	TAPON PARA YOKE	YOKE SCREW	RR1010114
16	OR TAPON HP (BOLSA DE 10PZ)	HP PLUG OR (10 PC BAG)	OR1010101
17	OR CUELLO PISTON NO BALANCEADO	NECK OR UNBALANCED PISTON	OR1010102
18	OR TAPON BP (BOLSA DE 10PZ)	HP PLUG OR (10 PC BAG)	OR1010103
19	OR 2037	OR 2037	OR1210101
20	OR 2056	OR 2056	OR1210102
21	OR PARA PISTON NO BALANCEADO	NO BALANCED PISTON OR	OR1010106
22	OR 3050	OR 3049	OR1010107
23	ORM 0110-25 70	ORM 0110-25 69	OR1010108

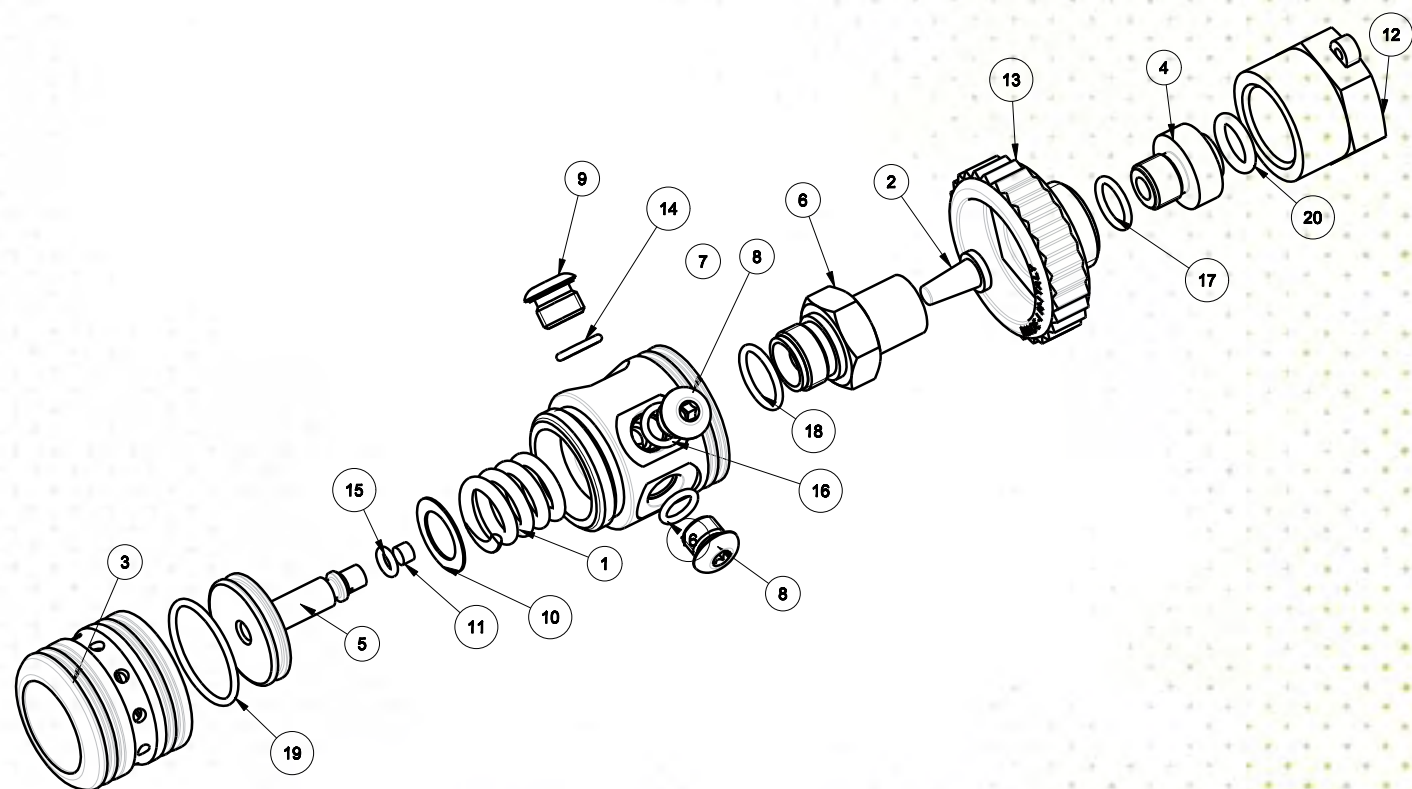
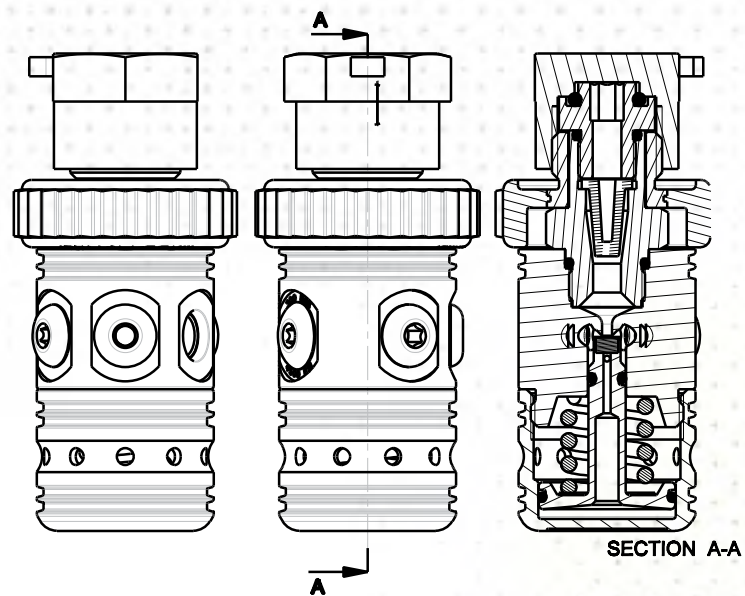

Numero	ES	EN	Referencia
1	RESORTE PISTON NO BALANCEADO	UNBALANCED PISTON SPRING	RR1010101
2	FILTRO CONICO DIN	DIN CONE-SHAPED FILTER	RR1210101
3	TAPA CON ROSCA DE METAL	UNBALANCED PISTON CAP	RR1010103
4	CONEXION 200 BAR/3000 PSI	CONNEXION 200 BAR/3000 PSI	RR1210102
5	PISTON NO BALANCEADO	UNBALANCED PISTON	RR1010107
6	ROSCA PARA CONEXION 200 BAR/3000 PSI	CONNEXION NUT 200 BAR/3000 PSI	RR1210103
7	CUERPO PRIMERA ETAPA PISTON NO BALANCEADO	UNBALANCED PISTON FIRST STAGE BODY	RR1010109
8	TAPON BP 3/8	LP PLUG 3/8	RR1210105
9	TAPON HP 7/16	HP PLUG 7/16	RR1210106
10	RONDANA DE TEFLON	SETTING WASHER	RR1010112
11	ASIENTO PRIMERA ETAPA EOLO	UNBALANCED PISTON SEAT	RR1010106
12	TAPON ANTIPOLVO DIN	DIN CAP	RA12101D
13	ROSCA DIN 200 BAR/3000 PSI	DIN NUT 200 BAR/3000 PSI	RR1210104
14	OR TAPON HP (BOLSA DE 10PZ)	HP PLUG OR (10 PC BAG)	OR1010101
15	OR CUELLO PISTON NO BALANCEADO	NECK OR UNBALANCED PISTON	OR1010102
16	OR TAPON BP (BOLSA DE 10PZ)	HP PLUG OR (10 PC BAG)	OR1010103
17	OR ENTRE ROSCA Y CONNEXION	OR BETWEEN NUT AND CONNEXION	OR1010109
18	OR PARA ROSCA P/CONEXION	CONNEXION NUT OR	OR1010110
19	OR PARA PISTON NO BALANCEADO	NO BALANCED PISTON OR	OR1010106
20	OR 3050	OR 3049	OR1010107

ZEPHYR FIRST STAGE DIN DIAGRAM

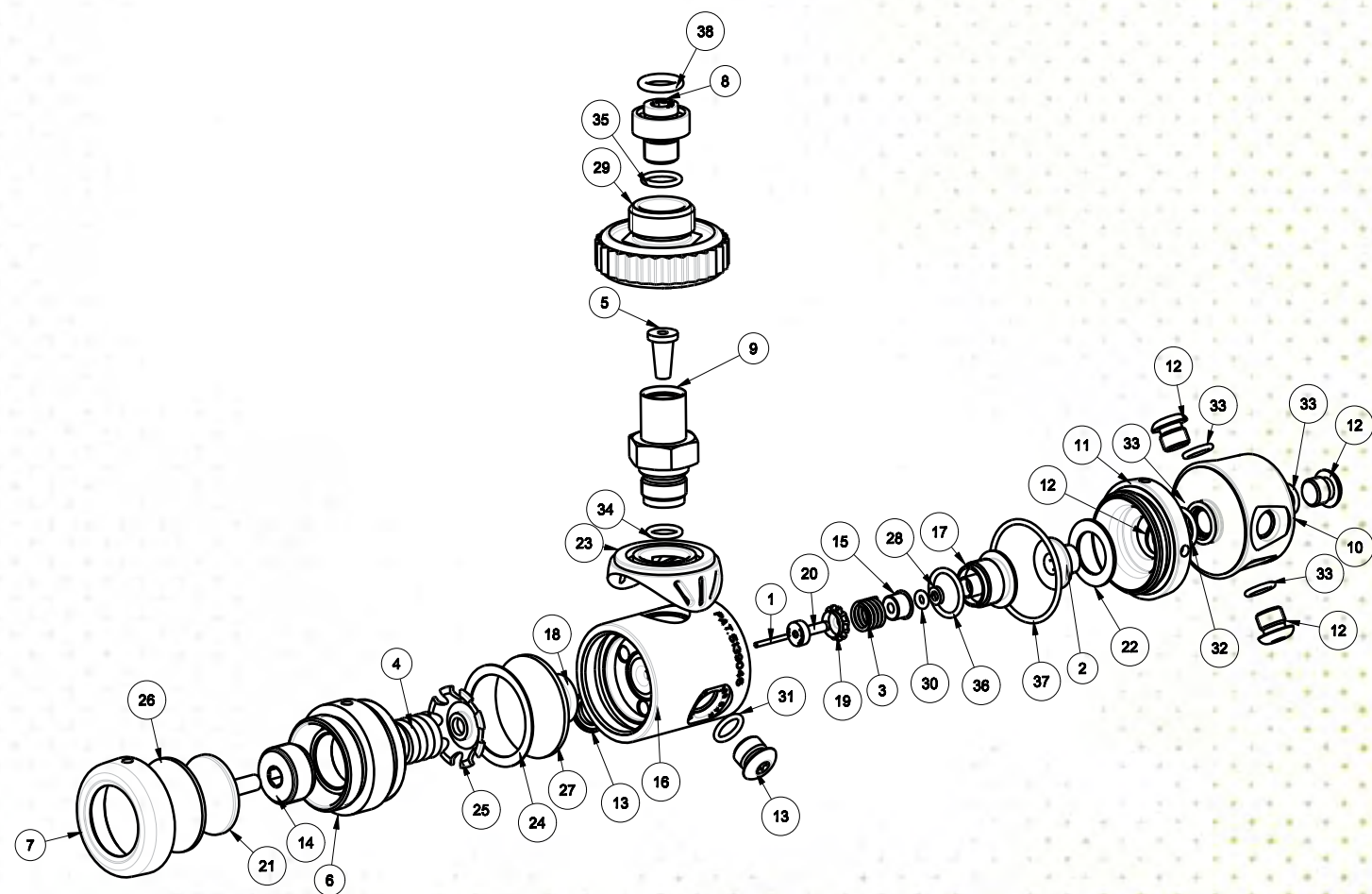
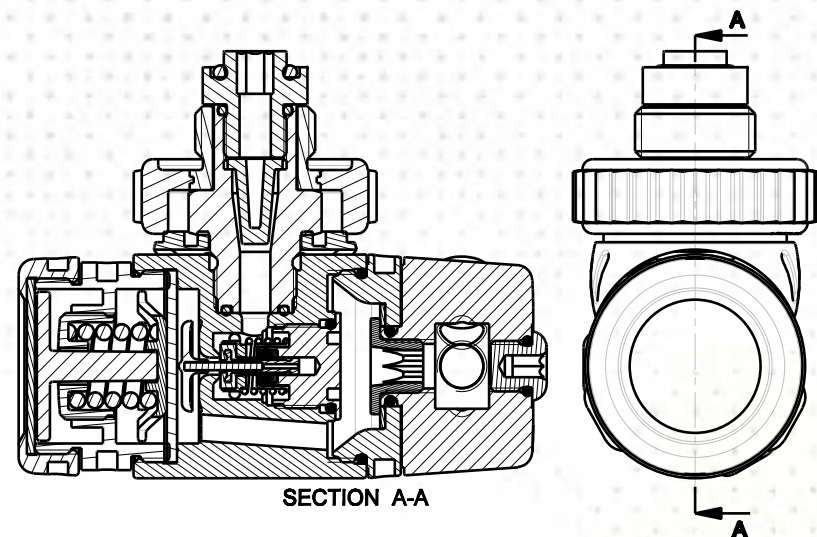

Numero	ES	EN	Referencia
1	PERNO GUIA		RR2010101
2	TORNILLO	SCREW	RR2010102
3	RESORTE PARA PISTON	PISTON SPRING	RR2010103
4	RESORTE PARA CALIBRACION PRESION INTERMEDIA	CALIBRATE SPRING	RR2010104
5	FILTRO CONICO DIN	DIN CONE-SHAPED FILTER	RR1210101
6	ANILLO INTERMEDIO	INTERMEDIATE RING	RR2010105
7	TAPON ANTIFREEZE	ANTIFREEZE CAP	RR2010106
8	CONEXION 200 BAR/3000 PSI	CONNEXION 200 BAR/3000 PSI	RR1210102
9	ROSCA PARA CONEXION 200 BAR/3000 PSI	CONNEXION NUT 200 BAR/3000 PSI	RR1210103
10	TORRETA GIRATORIA	SCREW TOWER	RR2010107
11	SOPORTE PARA TORRETA	TOWER SUPPORT	RR2010108
12	TAPON BP 3/8	LP PLUG 3/8	RR1210105
13	TAPON HP 7/16	HP PLUG 7/16	RR1210106
14	ROSCA PARA CALIBRAR PRESION INTERMEDIA	CALIBRATION INTERMIDIUM PRESSURE NUT	RR2010109
15	GUIA PARA RESORTE	SPRING SUPPORT	RR2010110
16	CUERPO PRIMERA ETAPA BALANCEADO	BALANCES FIRST STAGE BODY	RR2010111
17	CUARTO DE BALANCEO	BALANCING CHAMBER	RR2010112
18	DISCO	DISK	RR2010113
19	SEDE PARA PISTON	PISTON NUT	RR2010114
20	PISTON	PISTON	RR2010115
21	PLATO ANTIFREEZE	ANTIFREEZE PLATE	RR2010116
22	RONDANA EN TEFLON	TEFLON WASHER	RR2010117
23	SILLA	SADDLE	RR2010118
24	RONDANA PARA MEMBRANA	DIAPHRAGM WASHER	RR2010119
25	SOPORTE PARA RESORTE CALIBRACION	CALIBRATE SPRING SUPPORT	RR2010120
26	MEMBRANA ANTIFREEZE	ANTIFREEZE DIAPHRAGM	RR2010121
27	MEMBRANA PRIMERA ETAPA	FIRST STAGE DIAPHRAGM	RR2010122
28	ANILLO DE PLASTICO	PLASTIC RING	RR2010123
29	ROSCA DIN 200	NUT DIN 200	RR1210104
30	OR 2012	OR 2012	OR2010101
31	OR 108	OR 108	OR2010102
32	OR 114	OR 114	OR2010103
33	OR 2031	OR 2031	OR1211201
34	OR 2037	OR 2037	OR1210101
35	OR 2043	OR 2043	OR2010104
36	OR 2056	OR 2056	OR1210102
37	OR 2131	OR 2131	OR2010105
38	OR 3043	OR 3043	OR2010106

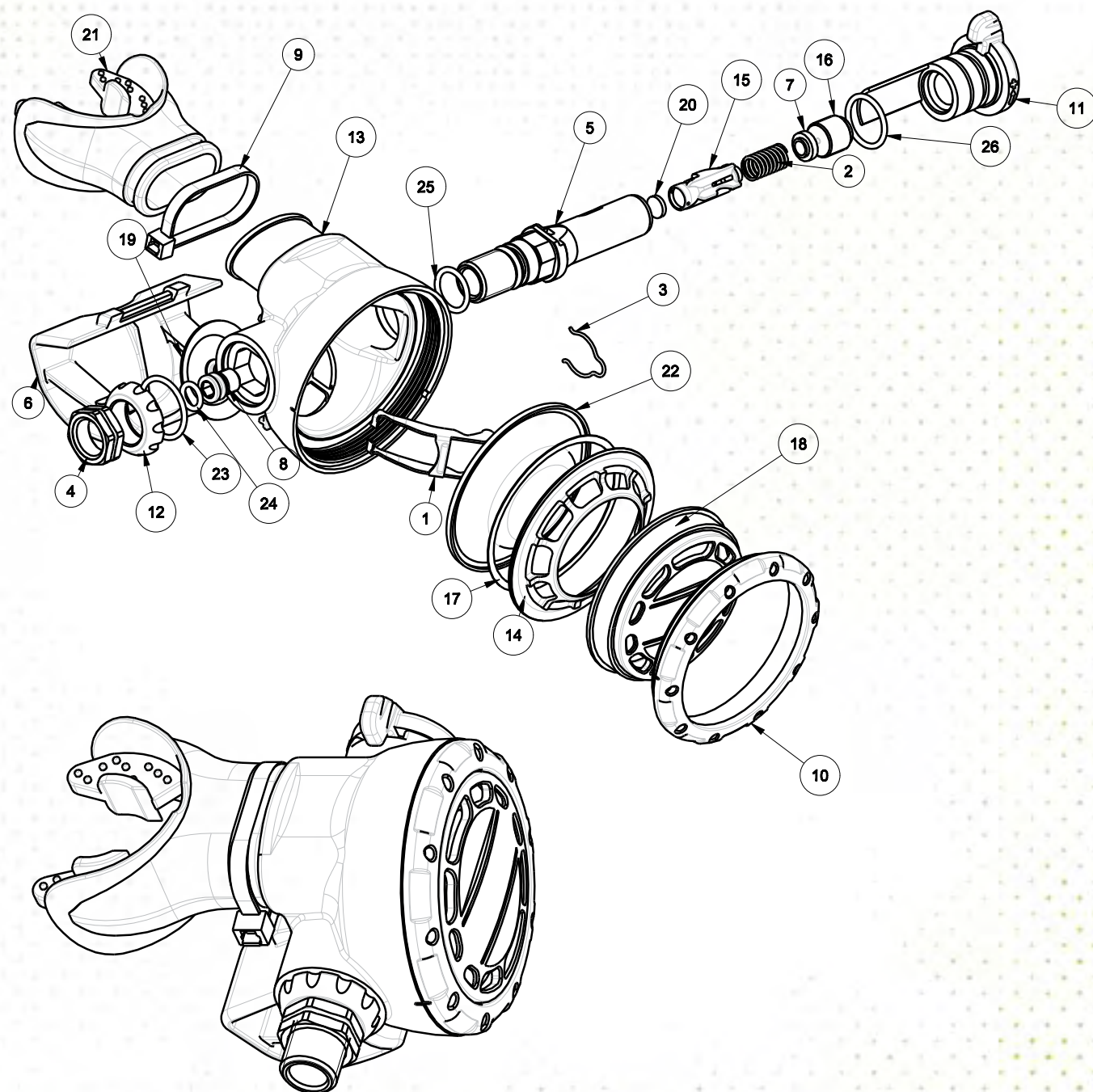

Numero	ES	EN	Referencia
1	LEVA	LEVER	RR1210203
2	RESORTE REGULACION SEGUNDA ETAPA	SPRING	RR1210206
3	CLIP STOP MANOPLA	CLIP	RR1010204
4	ROSCA	NUT	RR1210207
5	CUERPO VALVULA	BODY VALVE	RR1210208
6	BIGOTE	EXHAUST TEE	RR1210209
7	GUIA PARA RESORTE	SPRING SEAT	RR1210205
8	ORIFICIO	NOZZLE	RR1210210
9	STRAP BOQUILLA	MOUTHPIECE STRAP	RR1210211
10	ANILLO CON ROSCA PARA TAPA FRONTAL	COVER RETAINER RING	RR1210215
11	MANOPLA DIVE/PRE DIVE	DEFLECTOR DIVE/PRE DIVE	RR1210214
12	ANILLO DE RETENCION	RETAINING RING	RR1210212
13	CUERPO SEGUNDA ETAPA	CASE	RR1210213
14	PROTECTOR DE PLASTICO PARA MEMBRANA	DIAPHRAGM BEZEL	RR1210217
15	ARBOLITO	POPPET	RR1210204
16	TORNILLO TEFLON REGULACION SEGUNDA ETAPA	ADJUSTING SPRIN SCREW	RR1010203
17	RONDANA ANTIFRICCION	ANTIFRICTION WASHER	RR1210202
18	TAPA - COVER P/REGULADOR BONASSI-NEGRO	FRONT COVER	RA1210202
19	MEMBRANA DE PURGA	EXHAUST VALVE	RR1210216
20	PASTILLA PARA POPPET 2DA ETAPA	POPPET SEAT	RR1210201
21	BOQUILLA NEGRA SEGUNDA ETAPA	MOUTHPIECE	SRSB001
22	MEMBRANA	DIAPHRAGM	RR1210218
23	OR 2075	OR 2075	OR1210201
24	OR 106	OR 106	OR1210202
25	OR 2050	OR 2050	OR1210203
26	OR 2062	OR 2062	OR1210204

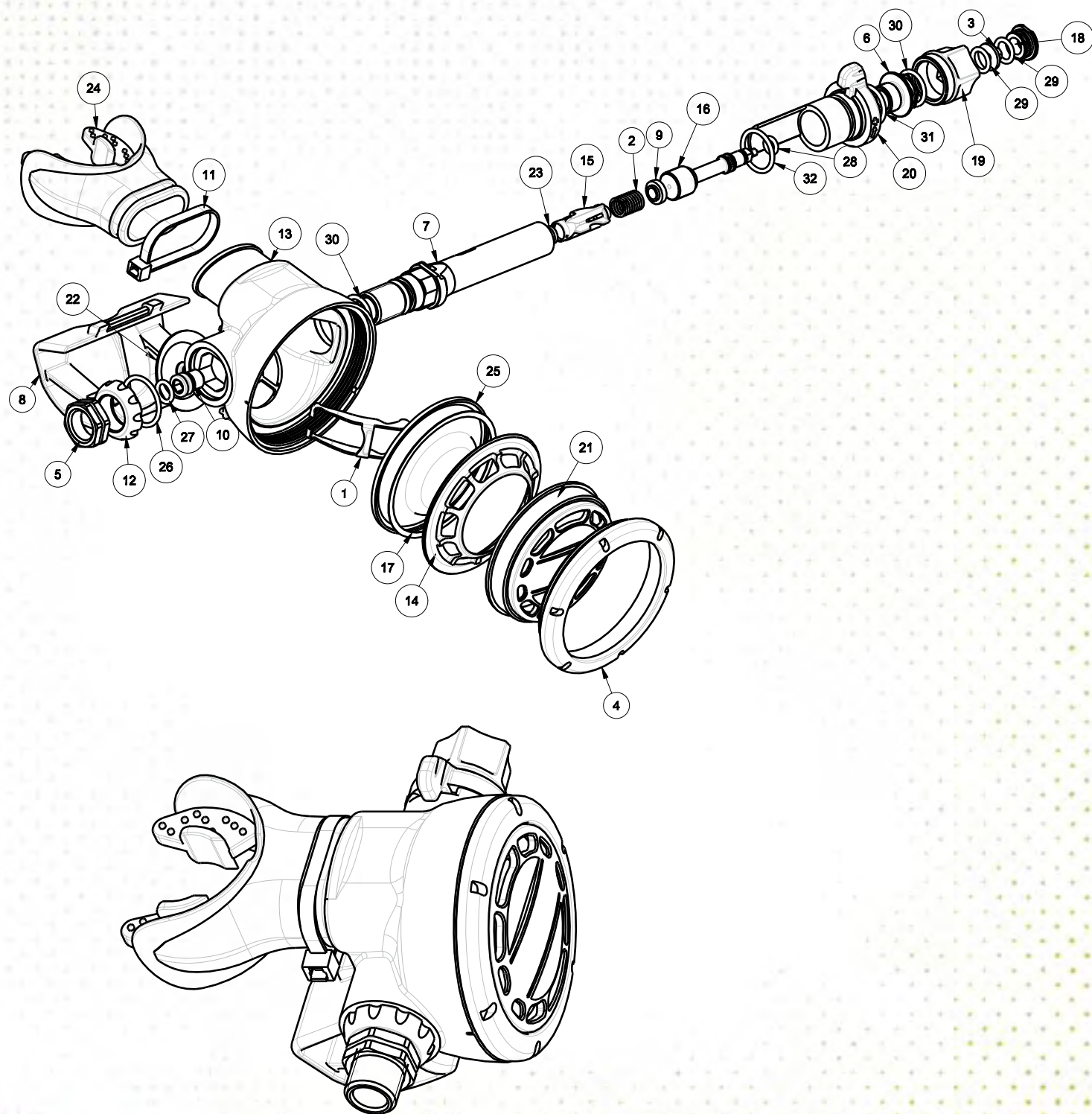

Numero	ES	EN	Referencia
1	LEVA	LEVER	RR1210203
2	RESORTE REGULACION SEGUNDA ETAPA	SPRING	RR1210206
3	ROSCA PEQUENA INTERNA	INSIDE SMALL NUT	RR2010207
4	ANILLO CON ROSCA PARA TAPA FRONTAL	COVER RETAINER RING	RR1210215
5	ROSCA	NUT	RR1210207
6	TAPON	PLUG	RR2010208
7	CUERPO VALVULA	BODY VALVE	RR1210208
8	BIGOTE	EXHAUST TEE	RR1210209
9	GUIA PARA RESORTE	SPRING SEAT	RR1210205
10	ORIFICIO	NOZZLE	RR1210210
11	BOQUILLA STRAP	MOUTHPIECE STRAP	RR1210211
12	ANILLO DE RETENCION	RETAINING RING	RR1210212
13	CUERPO SEGUNDA ETAPA	CASE	RR1210213
14	PROTECTOR DE PLASTICO PARA MEMBRANA	DIAPHRAGM BEZEL	RR1210217
15	ARBOLITO	POPPET	RR1210204
16	TORNILLO TEFLON REGULACION SEGUNDA ETAPA	ADJUSTING SPRIN SCREW ZEPHYR	RR2010209
17	RONDANA ANTIFRICCION	ANTIFRICTION WASHER	RR1210202
18	TAPON PARA MANOPLA DE REGULACION	ADJUSTING FLOW PLUG	RR2010210
19	AJUSTADOR DE FLUJO	ADJUSTING FLOW	RR2010211
20	MANOPLA DIVE/PRE DIVE	DEFLECTOR DIVE/PRE DIVE	RR1210214
21	TAPA - COVER P/REGULADOR BONASSI-NEGRO	FRONT COVER	RA1210202
22	MEMBRANA DE PURGA	EXHAUST VALVE	RR1210216
23	PASTILLA PARA POPPET 2DA ETAPA	POPPET SEAT	RR1210201
24	BOQUILLA NEGRA SEGUNDA ETAPA	MOUTHPIECE	SRSB001
25	MEMBRANA	DIAPHRAGM	RR1210218
26	OR 2075	OR 2075	OR1210201
27	OR106	OR106	OR1210202
28	OR 2018	OR 2018	OR2010201
29	OR 2031	OR 2031	OR1211201
30	OR 2050	OR 2050	OR1210203
31	OR 2056	OR 2056	OR1210102
32	OR 2062	OR 2062	OR1210204

INFLATOR FOR DOC-KOMBAT



Numero	ES	EN	Referencia
1	SOLO CUERPO INFLADOR KOALA-DOC-KOMBAT	INFLATOR BODY ONLY KOALA-DOC-KOMBAT	CHKO01
2	CASQUILLO DE METAL X01 DOC-KOMBAT	LOAD BUSHING X01 DOC-KOMBAT	CHTE02
3	BOTON DE CARGA DE METAL X01 DOC-KOMBAT	LOAD BUTTON X01 DOC-KOMBAT	CHTE03
4	BOTON DE DESCARGA DE METAL X01 DOC-KOMBAT	EXHAUST BUTTON X01 DOC-KOMBAT	CHTE04
5	PERNO DE DESCARGA DE METAL X01K DOC-KOMBAT	EXHAUST MUSHROOM X01 DOC-KOMBAT	CHTE05
6	MACHO CONEXION MANGUERA UNIVERSAL	MALE CONNECTION HOSE	CHKO06
7	RESORTE DE CARGA X01 KOALA-DOC-KOMBAT	LOAD SPRING X01 KOALA-DOC-KOMBAT	CHKO07
8	RESORTE DE DESCARGA X01 KOALA-DOC-KOMBAT	EXHAUST SPRING X01 KOALA-DOC-KOMBAT	CHKO08
9	PISTON DE CARGA X01 DOC-KOMBAT	LOAD PINSTON X01 DOC-KOMBAT	CHTE09
10	PIN PARA CABLE INOX KOALA-DOC-KANGU-KOMBAT	PIN FOR INOX CORD KOALA-DOC-KANGU-KOMBAT	CHKO10
11	OR 106	OR 106	CHKO11
12	OR 13X3 EP850	OR 13X3 EP851	CHKO12
13	OR 119	OR 119	CHKO13
14	OR 2055	OR 2056	CHKO14
15	OR 2061	OR 2062	CHKO15
16	OR R3 90 SHA	OR R3 90 SHA	CHKO16
17	OR R3 80 SHA	OR R3 80 SHA	CHKO17
18	BOQUILLA INFLADOR KOALA-DOC-KOMBAT	MOUTH PIECE X01	CHKO18
19	TUERCA DE DESCARGA X01K	EXHAUST BUSHING X01K	CHKO19

INFLATOR FOR DOC-KOMBAT



Numero	ES	EN	Referencia
1	SOLO CUERPO INFLADOR KOALA-DOC-KOMBAT	INFLATOR BODY ONLY KOALA-DOC-KOMBAT	CHKO01
2	CASQUILLO (X01K) KOALA	LOAD BUSHING X01L/K KOALA	CHKO02
3	BOTON DE CARGA (X01K) KOALA	LOAD BUTTON X01K KOALA	CHKO03
4	BOTON DE DESCARGA (X01K) KOALA	EXHAUST BUTTON X01K KOALA	CHKO04
5	PERNO DE DESCARGA (X01K) KOALA	EXHAUST MUSHROOM X01K KOALA	CHKO05
6	MACHO CONEXION MANGUERA UNIVERSAL	MALE CONNECTION HOSE	CHKO06
7	RESORTE DE CARGA X01 KOALA-DOC-KOMBAT	LOAD SPRING X01 KOALA-DOC-KOMBAT	CHKO07
8	RESORTE DE DESCARGA X01 KOALA-DOC-KOMBAT	EXHAUST SPRING X01 KOALA-DOC-KOMBAT	CHKO08
9	PISTON DE CARGA X01L/K KOALA	LOAD PISTON X01L/K KOALA	CHKO09
10	PIN PARA CABLE INOX KOALA-DOC-KANGU-KOMBAT	PIN FOR INOX CORD KOALA-DOC-KANGU-KOMBAT	CHKO10
11	OR 106	OR 106	CHKO11
12	OR 13X3 EP850	OR 13X3 EP851	CHKO12
13	OR 119	OR 119	CHKO13
14	OR 2055	OR 2056	CHKO14
15	OR 2061	OR 2062	CHKO15
16	OR R3 90 SHA	OR R3 90 SHA	CHKO16
17	OR R3 80 SHA	OR R3 80 SHA	CHKO17
18	BOQUILLA INFLADOR KOALA-DOC-KOMBAT	MOUTH PIECE X01	CHKO18
19	TUERCA DE DESCARGA X01K	EXHAUST BUSHING X01K	CHKO19

INFLATOR FOR KANGU



Numero	ES	EN	Referencia
1	SOLO CUERPO KANGU	CCBP BASE	CHKA01
2	BOTON DE DESCARGA KANGU	EXHAUST BUTTON BLACK	CHKA02
3	BOTON DE CARGA KANGU	LOAD BUTTON BLACK	CHKA03
4	CASQUILLO DE DESCARGA KANGU	EXHAUST BUSHING V01	CHKA04
5	TUERCA DE DESCARGA KANGU	EXHAUST SCREW NUT	CHKA05
6	RONDANA DE CARGA KANGU	LOAD WASHER	CHKA06
7	SEGURO	BUSHING TONGUE	CHKA07
8	MACHO CONEXION MANGUERA KOALA-KANGU-DOC-KOMBAT	MALE CONNECTION HOSE KOALA-KANGU-DOC-KOMBAT	CHKO06
9	RESORTE DE CARGA KANGU	LOAD SPRING	CHKA09
10	RESORTE DE DESCARGA KANGU	EXHAUST SPRING	CHKA10
11	PIN PARA CABLE INOX KOALA-DOC-KANGU-KOMBAT	PIN FOR INOX CORD KOALA-DOC-KANGU-KOMBAT	CHKO10
12	PIN DE CARGA	LOAD PIN	CHKA12
13	VALVULA PIVOTE	V3O02 EU	CHKA13
14	OR 106	OR 106	CHKA14
15	OR 2031	OR 2031	CHKA15
16	OR 2068	OR 2068	CHKA16
17	OR 2081	OR 2081	CHKA17
18	O RING 117 PARA BOTON DE DESCARGA	OR 117	CHKA18
19	O RING 2037 PARA BOTON DE CARGA	OR 10.1 X 1.60	CHKA19



BONASSI

2023

   /BONASSI.OFFICIAL

WWW.BONASSI.IO

PHOTOGRAPHY: @ELESERENAFUSATO_UWPHOTO



BONASSI

   /BONASSI.OFFICIAL

2023

© ALL RIGHTS RESERVED BONASSI INC
2022-2023

WWW.BONASSI.IO

PHOTOGRAPHY: @JUANPOUJARCINEMA